



# 1.2W Low-EMI, Filterless, Mono Class D Amplifier with Stereo DirectDrive Headphone Amplifiers

## General Description

The MAX9770 combines a mono, filterless, Class D speaker amplifier and stereo DirectDrive headphone amplifiers in a single device. The MAX9770 operates from a single 2.5V to 5.5V supply and includes features that reduce external component count, system cost, board space, and offer improved audio reproduction.

The speaker amplifier makes use of Maxim's patented Class D architecture, providing Class AB performance with Class D efficiency, conserving board space, and extending battery life. The speaker amplifier delivers 1.2W into an 8 $\Omega$  load while offering efficiencies above 85%. A spread-spectrum scheme reduces radiated emissions caused by the modulation frequency. Furthermore, the MAX9770 oscillator can be synchronized to an external clock through the SYNC input, avoiding possible problem frequencies inside a system. The speaker amplifier features a low 0.025% THD+N, high 70dB PSRR, and SNR in excess of 90dB.

The headphone amplifiers feature Maxim's patented DirectDrive architecture that produces a ground-referenced output from a single supply, eliminating the need for large DC-blocking capacitors. The headphone amplifiers deliver up to 80mW into a 16 $\Omega$  load, feature low 0.015% THD+N, high 80dB PSRR, and  $\pm$ 8kV ESD-protected outputs. A headphone sense input detects the presence of a headphone, and automatically configures the amplifiers for either speaker or headphone mode.

The MAX9770 includes internally set, logic-selectable gain, and a comprehensive input multiplexer/mixer, allowing multiple audio sources to be selected and for true mono reproduction of a stereo source in speaker mode. Industry-leading click-and-pop suppression eliminates audible transients during power and shutdown cycles. A low-power shutdown mode decreases supply current consumption to 0.1 $\mu$ A, further extending battery life.

The MAX9770 is offered in space-saving, thermally efficient 28-pin TQFN (5mm x 5mm x 0.8mm) and 28-pin TSSOP packages. The MAX9770 features thermal-overload and output short-circuit protection, and is specified over the extended -40°C to +85°C temperature range.

## Applications

Cellular Phones  
PDAs  
Compact Notebooks

Pin Configuration appears at end of data sheet.



## Features

- ◆ 1.2W Filterless Class D Amplifier Passes FCC Class B Radiated Emissions Standards with 100mm of Cable
- ◆ Unique Spread-Spectrum Mode Offers 5dB Emissions Improvement Over Conventional Methods
- ◆ 80mW DirectDrive Headphone Amplifier Eliminates Bulky DC-Blocking Capacitors
- ◆ High 80dB PSRR at 217Hz
- ◆ 85% Efficiency
- ◆ Low 0.015% THD+N
- ◆ Industry-Leading Click-and-Pop Suppression
- ◆ Integrated 3-Way Input Mixer/Multiplexer
- ◆ Logic-Selectable Gain
- ◆ Short-Circuit and Thermal Protection
- ◆  $\pm$ 8kV ESD-Protected Headphone Outputs
- ◆ Low-Power Shutdown Mode
- ◆ Available in Space-Saving, Thermally Efficient Packages
  - 28-Pin TQFN (5mm x 5mm x 0.8mm)
  - 28-Pin TSSOP

## Ordering Information

PART	TEMP RANGE	PIN-PACKAGE
MAX9770ETI†	-40°C to +85°C	28 TQFN-EP*
MAX9770EUI	-40°C to +85°C	28 TSSOP

†Lead-free package.

\*EP = Exposed paddle.

## Simplified Block Diagram

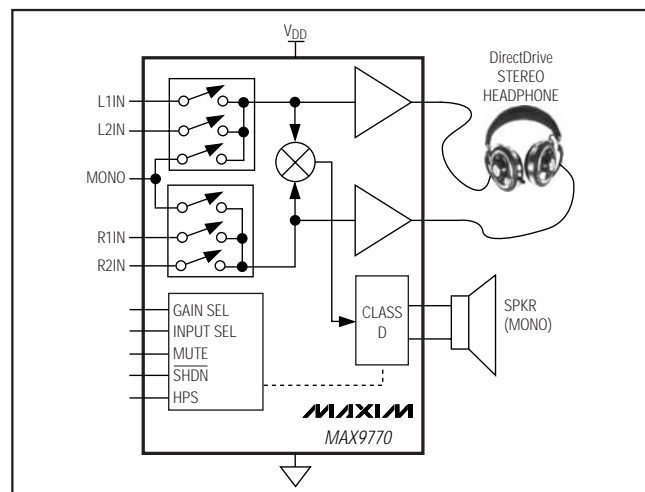

MAX9770

# 1.2W Low-EMI, Filterless, Mono Class D Amplifier with Stereo DirectDrive Headphone Amplifiers

## ABSOLUTE MAXIMUM RATINGS

GND to PGND to CPGND.....	-0.3V to +0.3V
V <sub>DD</sub> to PV <sub>DD</sub> to CPV <sub>DD</sub> .....	-0.3V to +0.3V
V <sub>DD</sub> to GND.....	6V
PV <sub>DD</sub> to PGND.....	6V
CPV <sub>DD</sub> to CPGND.....	6V
CPV <sub>SS</sub> to CPGND.....	-6V
SV <sub>SS</sub> to GND.....	-6V
C1N.....	(PV <sub>SS</sub> - 0.3V) to (CPGND + 0.3V)
HPOUT <sub>-</sub> to GND.....	±3V
All other pins to GND.....	-0.3V to (V <sub>DD</sub> + 0.3V)
Continuous Current Into/Out of:	
PV <sub>DD</sub> , PGND, OUT <sub>-</sub> .....	600mA
PV <sub>SS</sub> .....	260mA

Duration of HPOUT <sub>-</sub> Short Circuit to V <sub>DD</sub> , PV <sub>DD</sub> , GND, PGND.....	Continuous
Duration of Short Circuit between HPOUTL and HPOUTR.....	Continuous
Duration of OUT <sub>-</sub> Short Circuit to V <sub>DD</sub> , PV <sub>DD</sub> , GND, PGND.....	10s
Duration of Short Circuit Between OUT+ and OUT-.....	10s
Continuous Power Dissipation (T <sub>A</sub> = +70°C)	
28-Pin TQFN (derate 20.8mW/°C above +70°C).....	1667mW
28-Pin TSSOP (derate 12.8mW/°C above +70°C).....	1026mW
Junction Temperature.....	+150°C
Operating Temperature Range.....	-40°C to +85°C
Storage Temperature Range.....	-65°C to +150°C
Lead Temperature (soldering, 10s).....	+300°C

Stresses beyond those listed under "Absolute Maximum Ratings" may cause permanent damage to the device. These are stress ratings only, and functional operation of the device at these or any other conditions beyond those indicated in the operational sections of the specifications is not implied. Exposure to absolute maximum rating conditions for extended periods may affect device reliability.

## ELECTRICAL CHARACTERISTICS

(V<sub>DD</sub> = PV<sub>DD</sub> = CPV<sub>DD</sub> = 3.3V, GND = PGND = CPGND = 0V,  $\overline{\text{SHDN}}$  = 3.3V, C1 = C2 = 1μF, C<sub>BIAS</sub> = 0.047μF, SYNC = GND, R<sub>L</sub> = ∞, speaker load connected between OUT+ and OUT-, headphone load connected between HPOUT<sub>-</sub> and GND, T<sub>A</sub> = T<sub>MIN</sub> to T<sub>MAX</sub>, unless otherwise noted. Typical values are at T<sub>A</sub> = +25°C.) (Notes 1, 2)

PARAMETER	SYMBOL	CONDITIONS		MIN	TYP	MAX	UNITS
<b>GENERAL</b>							
Supply Voltage Range	V <sub>DD</sub>	Inferred from PSRR test		2.5		5.5	V
Quiescent Supply Current	I <sub>DD</sub>	No load	Headphone mode		5.5	10	mA
			Speaker mode		5.2	7.5	
Shutdown Supply Current	I <sub>SHDN</sub>	$\overline{\text{SHDN}}$ = HPS = GND			0.1	10	μA
Shutdown to Full Operation	t <sub>ON</sub>				50		ms
Input Impedance	R <sub>IN</sub>	(Note 3)	MONO	7	10		kΩ
			INL <sub>-</sub> , INR <sub>-</sub>	14	20		
Bias Voltage	V <sub>BIAS</sub>			1.1	1.25	1.4	V
Feedthrough		From any unselected input to any output, f = 10kHz			70		dB
<b>SPEAKER AMPLIFIER (GAIN1 = GAIN2 = V<sub>DD</sub>, HPS = GND)</b>							
Output Offset Voltage	V <sub>OS</sub>				±15	±70	mV
Power-Supply Rejection Ratio	PSRR	(Note 4)	V <sub>DD</sub> = 2.5V to 5.5V	50	70		dB
			V <sub>RIPPLE</sub> = 200mV <sub>p-p</sub> , f = 217Hz		70		
			V <sub>RIPPLE</sub> = 200mV <sub>p-p</sub> , f = 1kHz		68		
			V <sub>RIPPLE</sub> = 200mV <sub>p-p</sub> , f = 20kHz		50		
Output Power	P <sub>OUT</sub>	f = 1kHz, THD+N = 1%, GAIN1 = 1, GAIN2 = 0	V <sub>DD</sub> = 3.3V	R <sub>L</sub> = 8Ω	550		mW
				R <sub>L</sub> = 4Ω	900		
			V <sub>DD</sub> = 5V	R <sub>L</sub> = 8Ω	1200		
Total Harmonic Distortion Plus Noise	THD+N	R <sub>L</sub> = 8Ω, P <sub>OUT</sub> = 300mW, f = 1kHz			0.025		%
		R <sub>L</sub> = 4Ω, P <sub>OUT</sub> = 300mW, f = 1kHz			0.03		

# 1.2W Low-EMI, Filterless, Mono Class D Amplifier with Stereo DirectDrive Headphone Amplifiers

## ELECTRICAL CHARACTERISTICS (continued)

( $V_{DD} = PV_{DD} = CPV_{DD} = 3.3V$ ,  $GND = PGND = CPGND = 0V$ ,  $\overline{SHDN} = 3.3V$ ,  $C1 = C2 = 1\mu F$ ,  $C_{BIAS} = 0.047\mu F$ ,  $SYNC = GND$ ,  $R_L = \infty$ , speaker load connected between  $OUT+$  and  $OUT-$ , headphone load connected between  $HPOUT_+$  and  $GND$ ,  $T_A = T_{MIN}$  to  $T_{MAX}$ , unless otherwise noted. Typical values are at  $T_A = +25^\circ C$ .) (Notes 1, 2)

PARAMETER	SYMBOL	CONDITIONS		MIN	TYP	MAX	UNITS
Signal-to-Noise Ratio	SNR	$R_L = 8\Omega$ , $V_{OUT} = 2V_{RMS}$ , A-weighted			85.9		dB
Output Switching Frequency	$F_S$	SYNC = GND		980	1100	1220	kHz
		SYNC = FLOAT		1280	1450	1620	
		SYNC = $V_{DD}$			1220 $\pm 120kHz$		
SYNC Frequency Lock Range				800		2000	kHz
Efficiency	$\eta$	$P_O = 1000mW$ , $f = 1kHz$			85		%
Gain	$A_V$	GAIN1 = 0, GAIN2 = 0			6		dB
		GAIN1 = 0, GAIN2 = 1			3		
		GAIN1 = 1, GAIN2 = 0			9		
		GAIN1 = 1, GAIN2 = 1			0		
Gain Accuracy						$\pm 5$	%
Speaker Path Off-Isolation		HPS = $V_{DD}$ , headphone amplifier active, $f = 1kHz$			102		dB
<b>HEADPHONE AMPLIFIER (GAIN1 = 1, GAIN2 = 0, HPS = <math>V_{DD}</math>)</b>							
Output Offset Voltage	$V_{OS}$				$\pm 5$	$\pm 10$	mV
Power-Supply Rejection Ratio	PSRR	(Note 3)	$V_{DD} = 2.5V$ to $5.5V$		65	76	dB
			$V_{RIPPLE} = 200mV_{P-P}$ , $f = 217kHz$			85	
			$V_{RIPPLE} = 200mV_{P-P}$ , $f = 1kHz$			82	
			$V_{RIPPLE} = 200mV_{P-P}$ , $f = 20kHz$			56	
Output Power	$P_{OUT}$	$f = 1kHz$ , THD+N = 1%	$V_{DD} = 3.3V$	$R_L = 32\Omega$	40	55	mW
				$R_L = 16\Omega$		40	
			$V_{DD} = 5V$	$R_L = 32\Omega$		60	
				$R_L = 16\Omega$		80	
Total Harmonic Distortion Plus Noise	THD+N	$R_L = 32\Omega$ , $P_{OUT} = 50mW$ , $f = 1kHz$			0.015		%
		$R_L = 16\Omega$ , $P_{OUT} = 35mW$ , $f = 1kHz$			0.03		
Signal-to-Noise Ratio	SNR	$R_L = 32\Omega$ , $V_{OUT} = 300mV_{RMS}$ , BW = 22Hz to 22kHz			101		dB
Crosstalk		Between channels, $f = 1kHz$ , $V_{IN} = 200mV_{P-P}$			80		dB
Headphone Off-Isolation		HPS = GND, speaker amplifier active, $f = 1kHz$			96		dB

# 1.2W Low-EMI, Filterless, Mono Class D Amplifier with Stereo DirectDrive Headphone Amplifiers

## ELECTRICAL CHARACTERISTICS (continued)

( $V_{DD} = PV_{DD} = CPV_{DD} = 3.3V$ ,  $GND = PGND = CPGND = 0V$ ,  $\overline{SHDN} = 3.3V$ ,  $C1 = C2 = 1\mu F$ ,  $C_{BIAS} = 0.047\mu F$ ,  $SYNC = GND$ ,  $R_L = \infty$ , speaker load connected between  $OUT+$  and  $OUT-$ , headphone load connected between  $HPOUT-$  and  $GND$ ,  $T_A = T_{MIN}$  to  $T_{MAX}$ , unless otherwise noted. Typical values are at  $T_A = +25^\circ C$ .) (Notes 1, 2)

PARAMETER	SYMBOL	CONDITIONS	MIN	TYP	MAX	UNITS
Capacitive-Load Drive	$C_L$			1000		pF
Gain	$A_V$	GAIN1 = 0, GAIN2 = 0		7		dB
		GAIN1 = 0, GAIN2 = 1		4		
		GAIN1 = 1, GAIN2 = 0		-2		
		GAIN1 = 1, GAIN2 = 1		1		
Gain Accuracy					$\pm 2.5$	%
ESD Protection		HPOUTR, HPOUTL, IEC Air Discharge		$\pm 8$		kV
<b>DIGITAL INPUTS (<math>\overline{SHDN}</math>, SYNC, HPS, GAIN_, SEL_)</b>						
Input Voltage High	$V_{IH}$		2			V
Input Voltage Low	$V_{IL}$				0.8	V
Input Leakage Current		SYNC input			$\pm 25$	$\mu A$
		All other logic inputs			$\pm 1$	
HPS Input Current		HPS = GND			-10	$\mu A$

**Note 1:** All devices are 100% production tested at  $+25^\circ C$ . All temperature limits are guaranteed by design.

**Note 2:** Speaker amplifier testing performed with a resistive load in series with an inductor to simulate an actual speaker load. For  $R_L = 4\Omega$ ,  $L = 47\mu H$ . For  $R_L = 8\Omega$ ,  $L = 68\mu H$ .

**Note 3:** Guaranteed by design, not production tested.

**Note 4:** PSRR is specified with the amplifier inputs connected to GND through  $C_{IN}$ .

## Typical Operating Characteristics

( $V_{DD} = 3.3V$ , BW = 22Hz to 22kHz, GAIN1 = 1, GAIN2 = 0, spread-spectrum mode, headphone outputs in phase.)

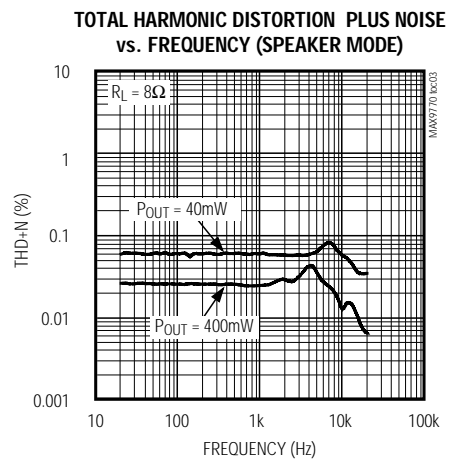
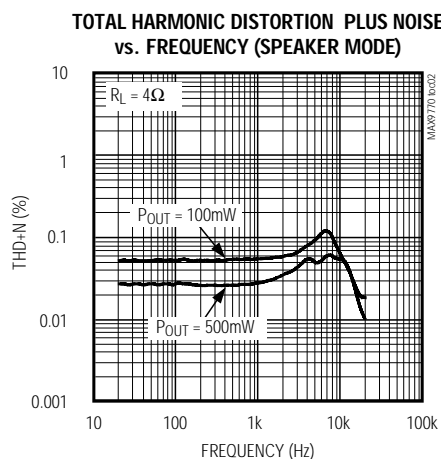
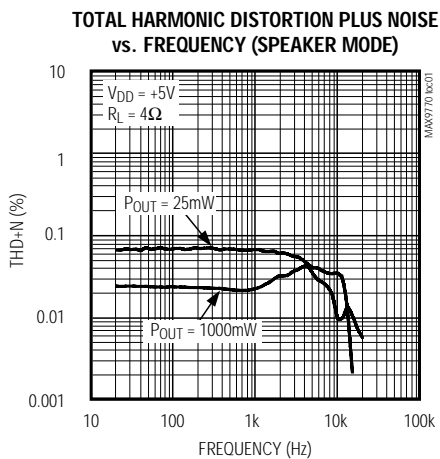

# 1.2W Low-EMI, Filterless, Mono Class D Amplifier with Stereo DirectDrive Headphone Amplifiers

MAX9770

## Typical Operating Characteristics (continued)

( $V_{DD} = 3.3V$ , BW = 22Hz to 22kHz, GAIN1 = 1, GAIN2 = 0, spread-spectrum mode, headphone outputs in phase.)

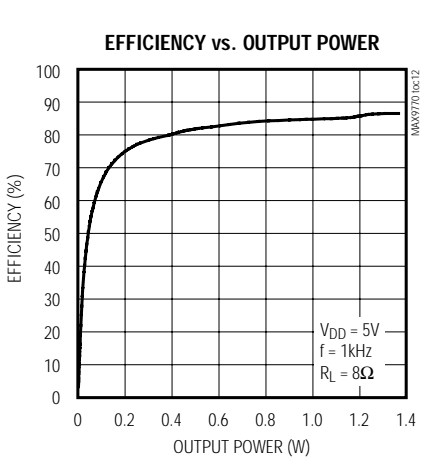
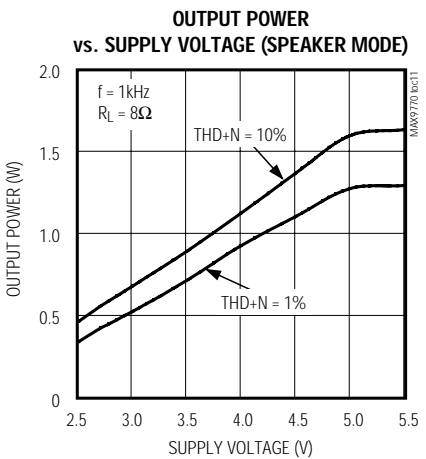
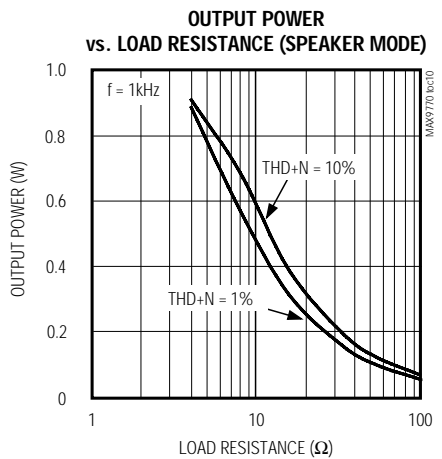
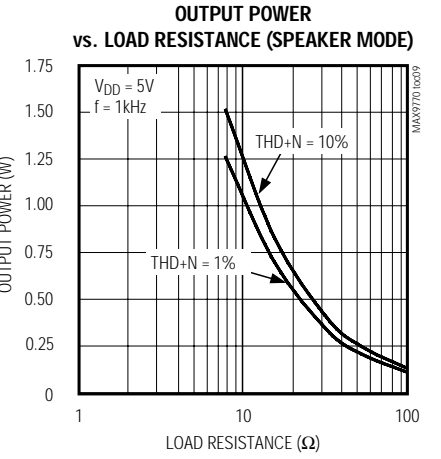
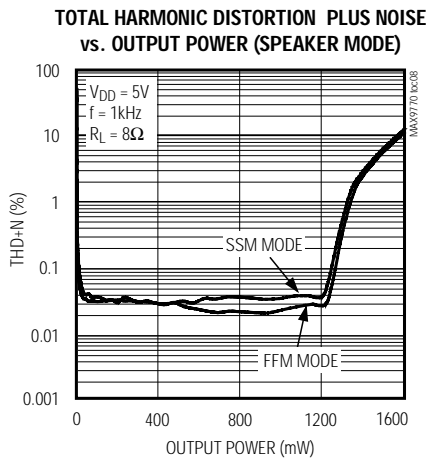
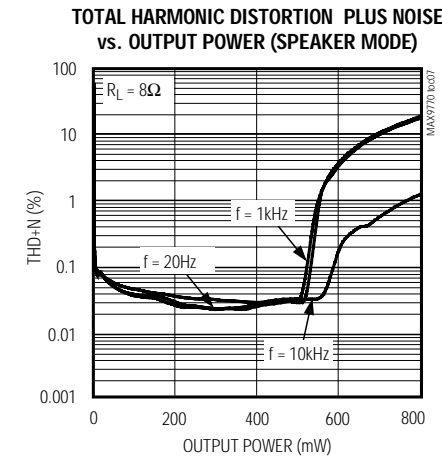
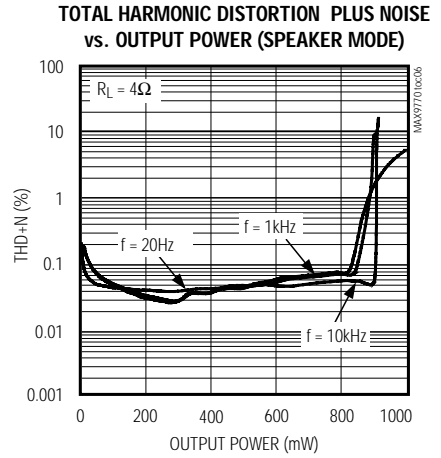
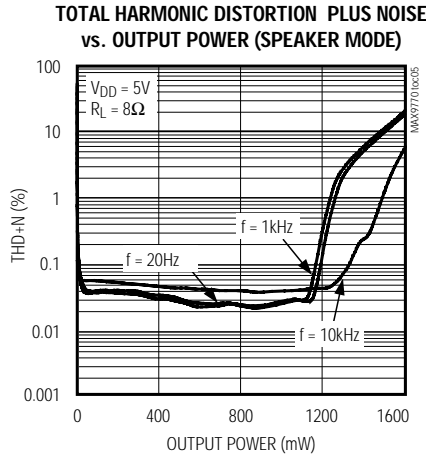
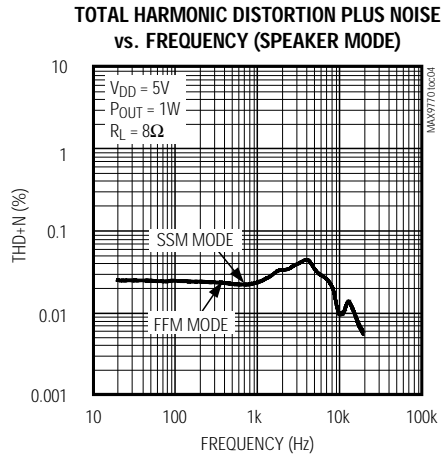

# 1.2W Low-EMI, Filterless, Mono Class D Amplifier with Stereo DirectDrive Headphone Amplifiers

## Typical Operating Characteristics (continued)

( $V_{DD} = 3.3V$ , BW = 22Hz to 22kHz, GAIN1 = 1, GAIN2 = 0, spread-spectrum mode, headphone outputs in phase.)

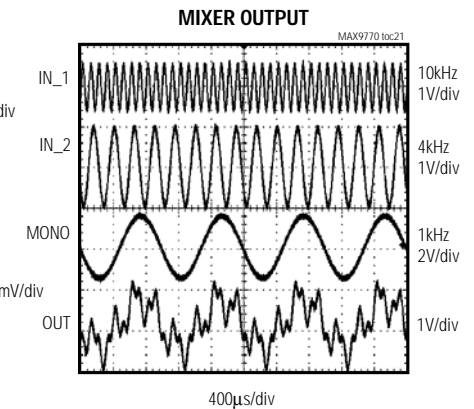
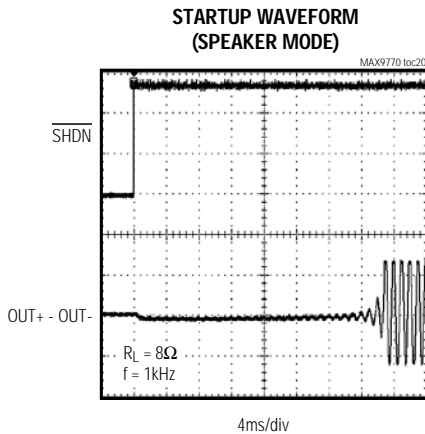
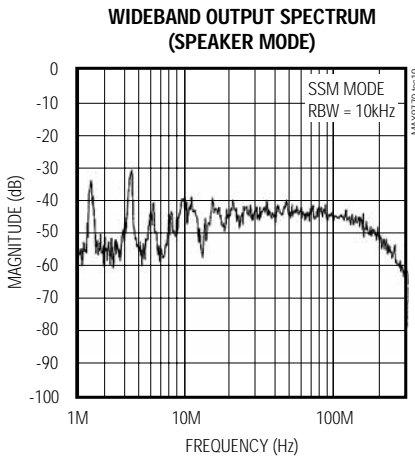
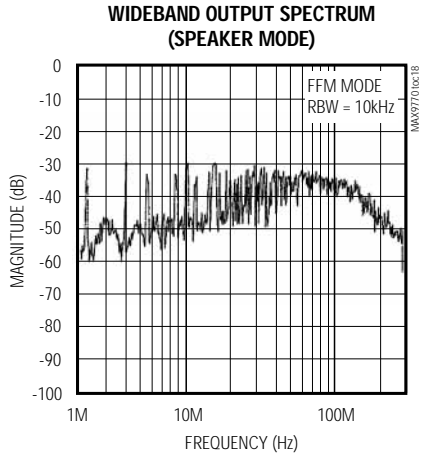
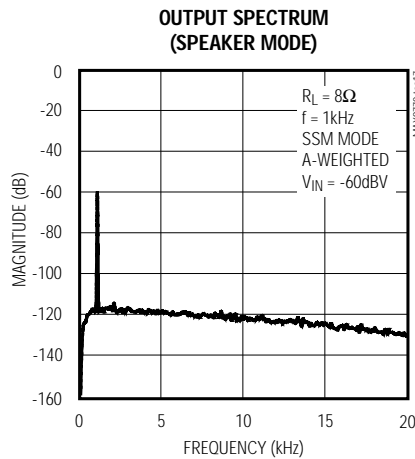
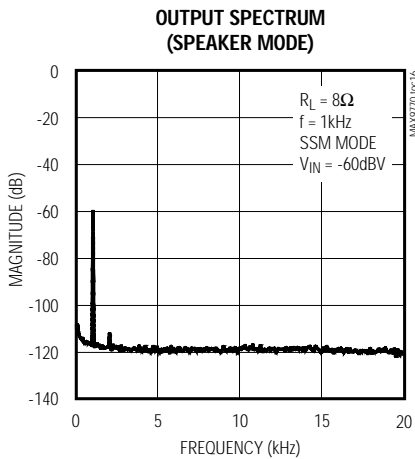
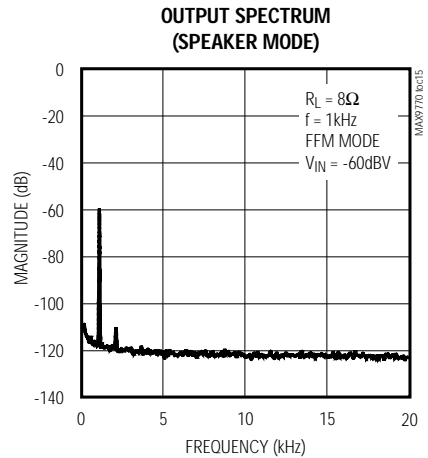
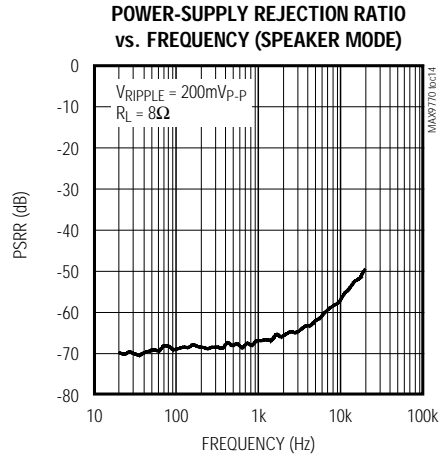
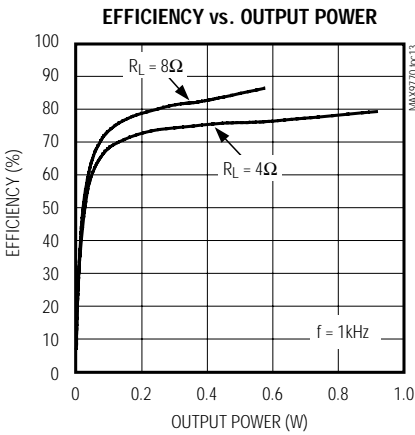

# 1.2W Low-EMI, Filterless, Mono Class D Amplifier with Stereo DirectDrive Headphone Amplifiers

## Typical Operating Characteristics (continued)

( $V_{DD} = 3.3V$ , BW = 22Hz to 22kHz, GAIN1 = 1, GAIN2 = 0, spread-spectrum mode, headphone outputs in phase.)

MAX9770

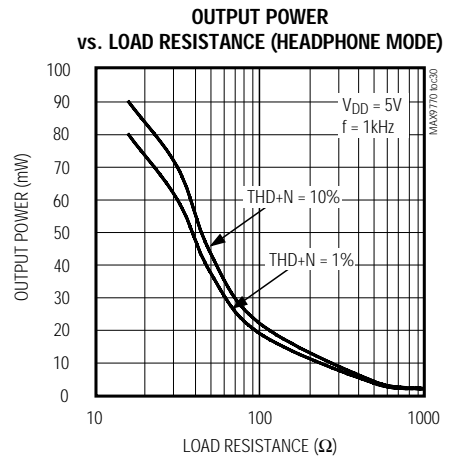
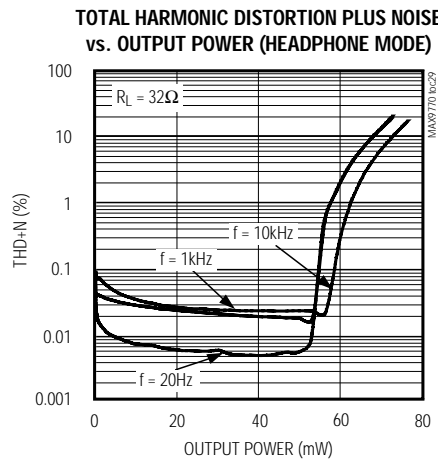
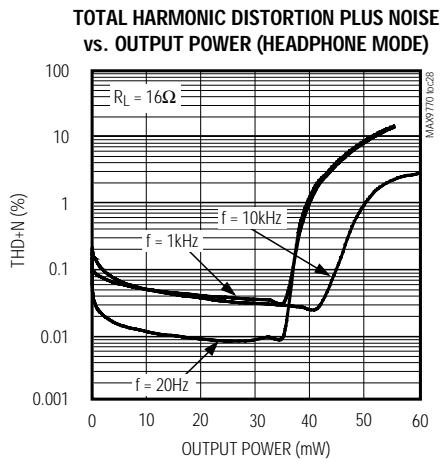
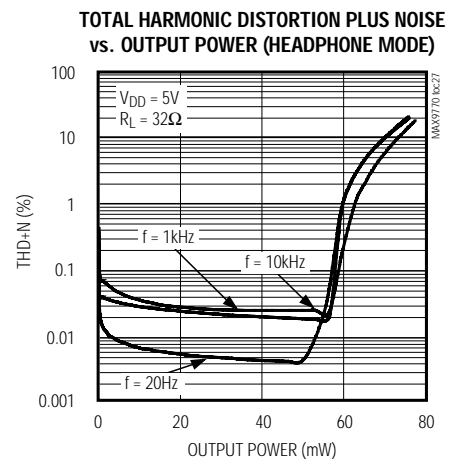
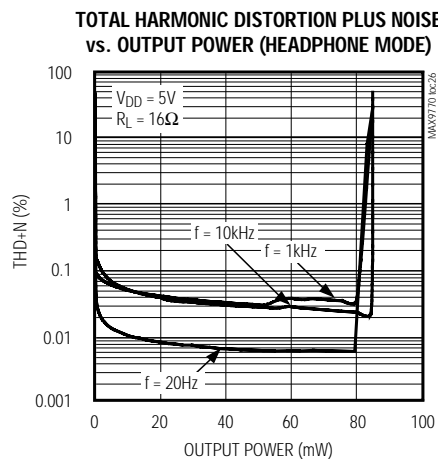
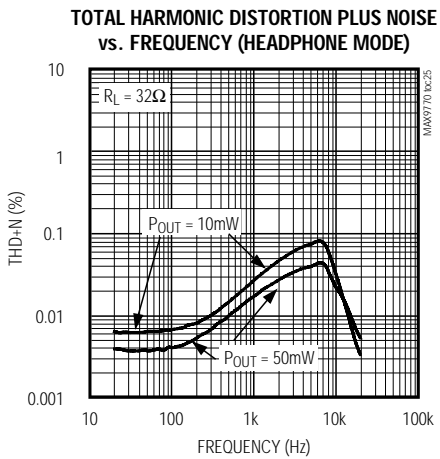
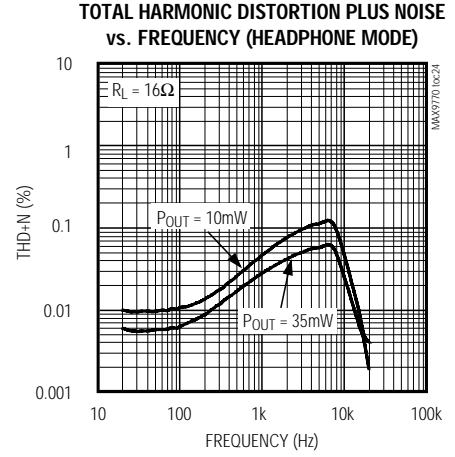
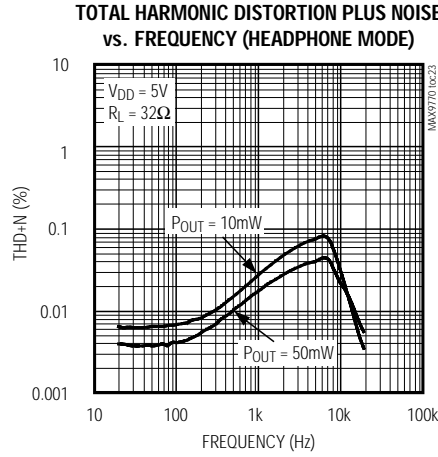
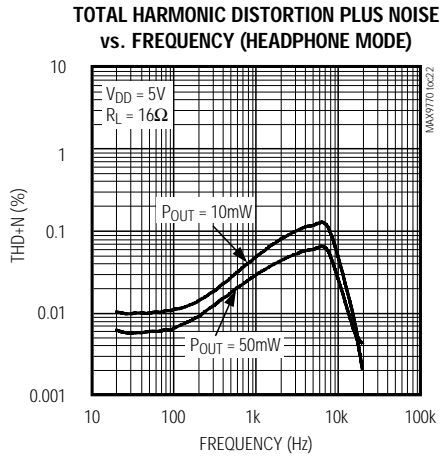

# 1.2W Low-EMI, Filterless, Mono Class D Amplifier with Stereo DirectDrive Headphone Amplifiers

## Typical Operating Characteristics (continued)

( $V_{DD} = 3.3V$ , BW = 22Hz to 22kHz, GAIN1 = 1, GAIN2 = 0, spread-spectrum mode, headphone outputs in phase.)

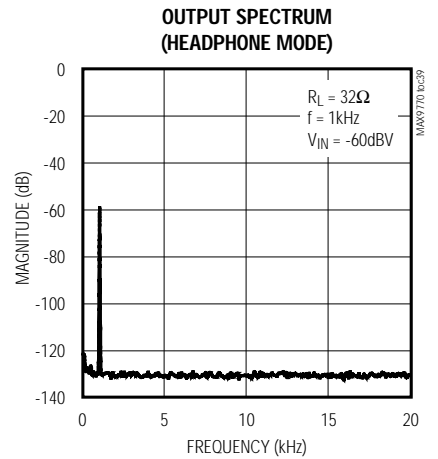
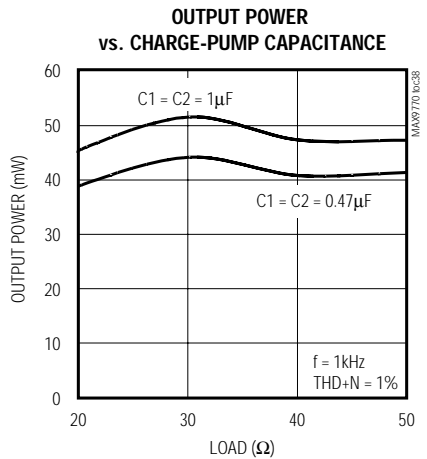
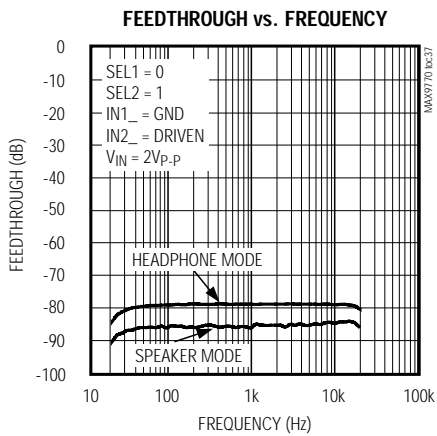
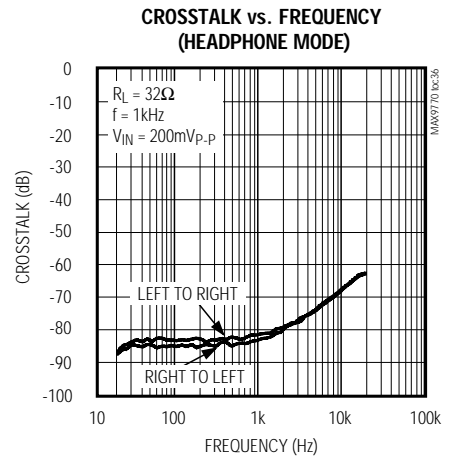
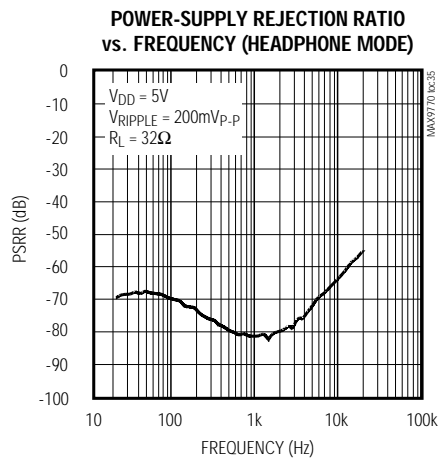
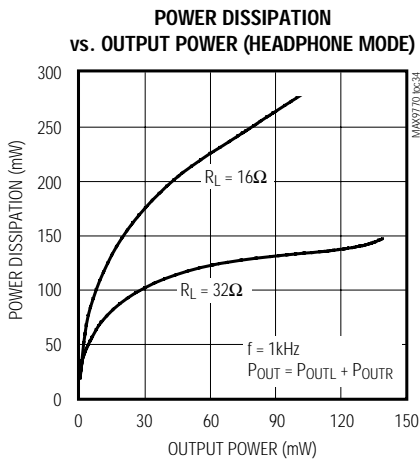
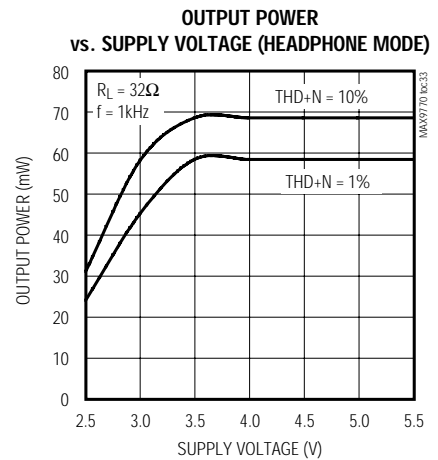
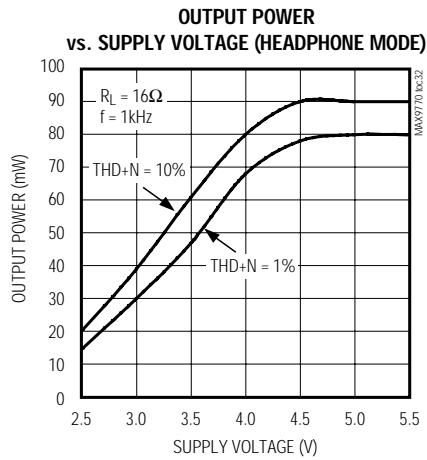
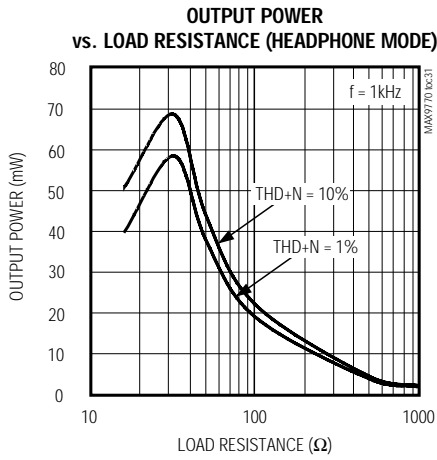



# 1.2W Low-EMI, Filterless, Mono Class D Amplifier with Stereo DirectDrive Headphone Amplifiers

## Typical Operating Characteristics (continued)

( $V_{DD} = 3.3V$ , BW = 22Hz to 22kHz, GAIN1 = 1, GAIN2 = 0, spread-spectrum mode, headphone outputs in phase.)

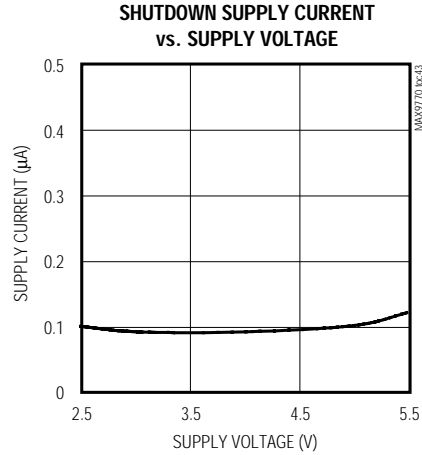
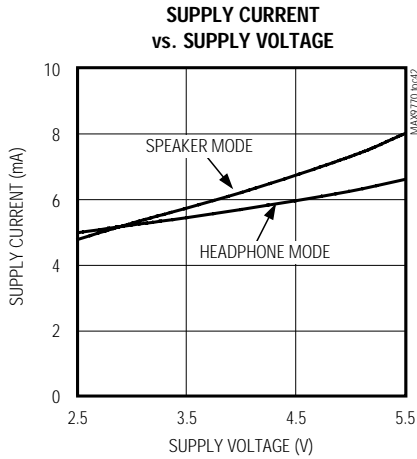
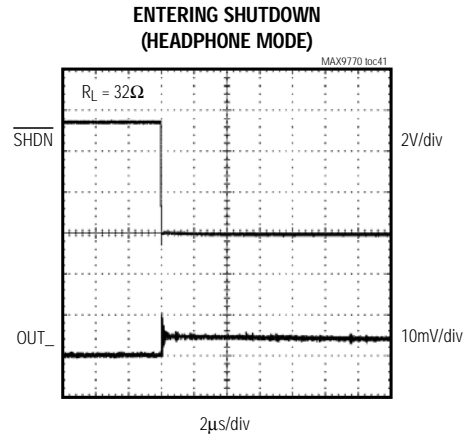
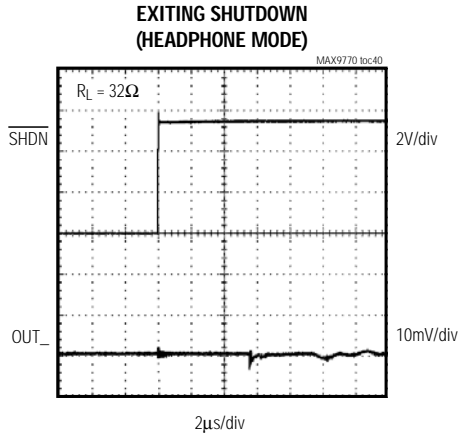

## Pin Description

PIN		NAME	FUNCTION
TQFN	TSSOP		
1	4	BIAS	Common-Mode Bias Voltage. Bypass with a 0.047μF capacitor to GND.
2	5	$V_{DD}$	Power Supply
3	6	HPOUTR	Right-Channel Headphone Output
4	7	HPOUTL	Left-Channel Headphone Output
5	8	SVSS	Headphone Amplifier Negative Power Supply
6	9	HPS	Headphone Sense Input

# 1.2W Low-EMI, Filterless, Mono Class D Amplifier with Stereo DirectDrive Headphone Amplifiers

## Pin Description (continued)

PIN		NAME	FUNCTION
TQFN	TSSOP		
7	10	CPVDD	Positive Charge-Pump Power Supply
8	11	CPVSS	Charge-Pump Output. Connect to SVSS.
9	12	C1N	Charge-Pump Flying Capacitor Negative Terminal
10	13	C1P	Charge-Pump Flying Capacitor Positive Terminal
11	14	CPGND	Charge-Pump Ground
12	15	SEL1	Select Stereo Channel 1 Inputs. Digital input. Drive SEL1 high to select inputs IN1_L and IN1_R.
13	16	SEL2	Select Stereo Channel 2 Inputs. Digital input. Drive SEL2 high to select inputs IN2_L and IN2_R.
14	17	SELM	Select Mono Channel Input. Digital input. Drive SELM high to select the MONO input.
15	18	$\overline{\text{SHDN}}$	Shutdown. Drive $\overline{\text{SHDN}}$ low to disable the device. Connect $\overline{\text{SHDN}}$ to VDD for normal operation.
16	19	SYNC	Frequency Select and External Clock Input. <b>SYNC = GND:</b> fixed-frequency PWM mode with $f_s = 1100\text{kHz}$ . <b>SYNC = Float:</b> fixed-frequency PWM mode with $f_s = 1450\text{kHz}$ . <b>SYNC = VDD:</b> spread-spectrum PWM mode with $f_s = 1220\text{kHz} \pm 120\text{kHz}$ . <b>SYNC = Clocked:</b> fixed-frequency PWM mode with $f_s = \text{external clock frequency}$ .
17	20	PGND	Speaker Amplifier Power Ground
18	21	OUT+	Speaker Amplifier Positive Output
19	22	OUT-	Speaker Amplifier Negative Output
20	23	PVDD	Speaker Amplifier Power Supply
21	24	GAIN2	Gain Control Input 2
22	25	GAIN1	Gain Control Input 1
23	26	MONO	Mono Channel Input
24	27	IN2_L	Stereo Channel 2, Left Input
25	28	IN1_L	Stereo Channel 1, Left Input
26	1	GND	Ground
27	2	IN2_R	Stereo Channel 2, Right Input
28	3	IN1_R	Stereo Channel 1, Right Input
EP	—	EP	Exposed Paddle. Can be left floating or tied to GND.

### Detailed Description

The MAX9770 combines a mono 1.2W Class D speaker amplifier and stereo 80mW DirectDrive headphone amplifiers with integrated headphone sensing and comprehensive click-and-pop suppression. A mixer/multiplexer allows for selection and mixing between two stereo input sources and a single mono source. The MAX9770 features a high 80dB PSRR, low 0.015% THD+N, industry-leading click/pop performance, and a low-power shutdown mode.

### Class D Speaker Amplifier

The MAX9770 Class D amplifier features a true filterless, low EMI, switch-mode architecture that provides Class AB-like performance with Class D efficiency. Comparators monitor the MAX9770 input and compare the input voltage to a sawtooth waveform. The comparators trip when the input magnitude of the sawtooth exceeds the corresponding input voltage. The comparator resets at a fixed time after the rising edge of the second comparator trip point, generating a minimum-

# 1.2W Low-EMI, Filterless, Mono Class D Amplifier with Stereo DirectDrive Headphone Amplifiers

width pulse  $t_{ON(min)}$  at the output of the second comparator (Figure 1). As the input voltage increases or decreases, the duration of the pulse at one output increases (the first comparator trip point) while the other output pulse duration remains at  $t_{ON(min)}$ . This causes the net voltage across the speaker ( $V_{OUT+} - V_{OUT-}$ ) to change.

### Operating Modes

The switching frequency of the charge pump is 1/2 the switching frequency of the Class D amplifier, regardless of the operating mode. When SYNC is driven externally, the charge pump switches at 1/2  $f_{SYNC}$ . When  $SYNC = V_{DD}$ , the charge pump switches with a spread-spectrum pattern.

**Table 1. Operating Modes**

SYNC INPUT	MODE
GND	FFPWM with $f_S = 1100\text{kHz}$
FLOAT	FFPWM with $f_S = 1450\text{kHz}$
$V_{DD}$	SSPWM with $f_S = 1220\text{kHz} \pm 120\text{kHz}$
Clocked	FFPWM with $f_S = \text{external clock frequency}$

### Fixed-Frequency Modulation (FFM) Mode

The MAX9770 features two FFM modes. The FFM modes are selected by setting  $SYNC = GND$  for a 1.1MHz switching frequency, and  $SYNC = FLOAT$  for a 1.45MHz switching frequency. In FFM mode, the frequency spectrum of the Class D output consists of the

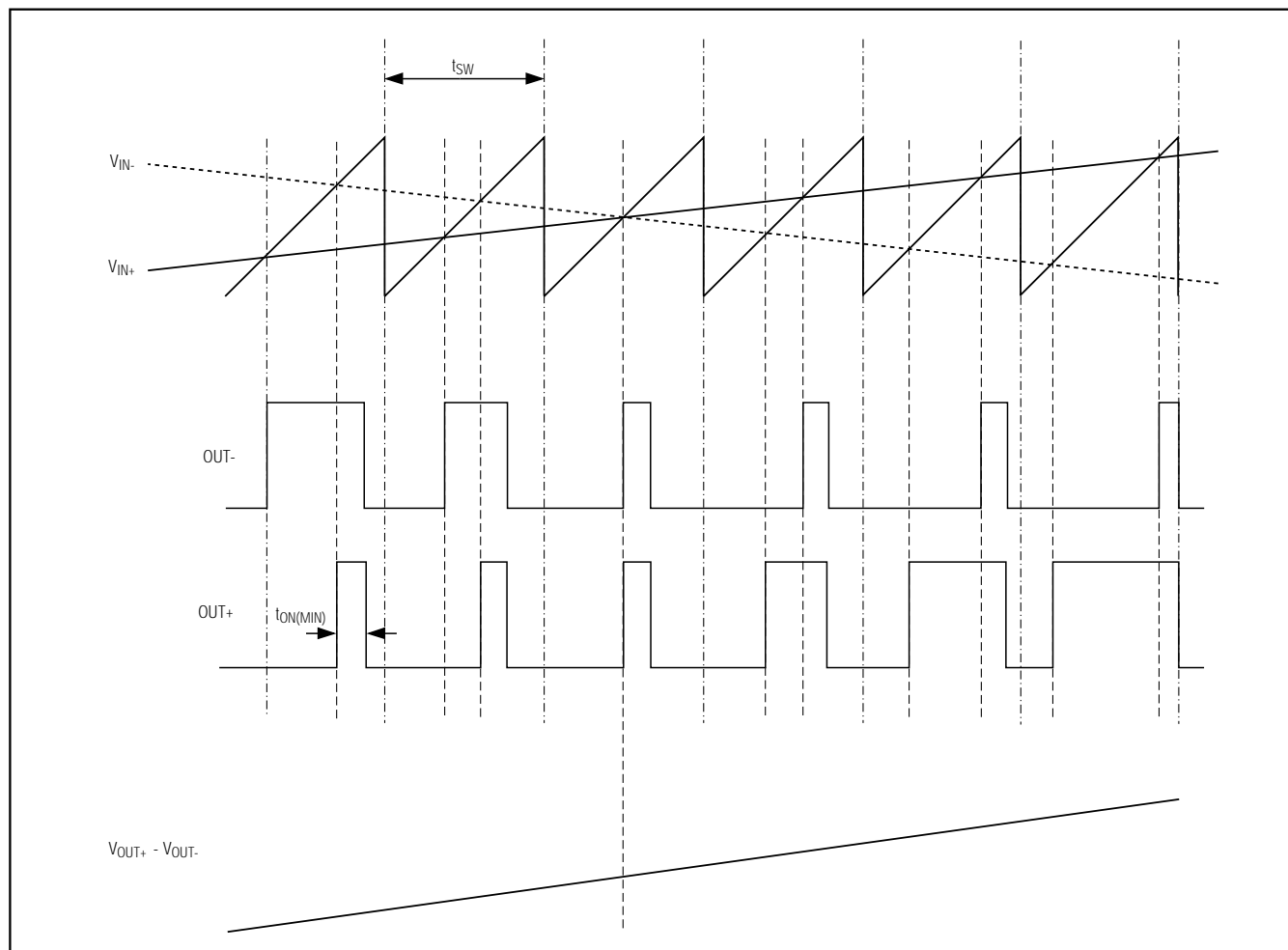

Figure 1. MAX9770 Outputs with an Input Signal Applied

# 1.2W Low-EMI, Filterless, Mono Class D Amplifier with Stereo DirectDrive Headphone Amplifiers

fundamental switching frequency and its associated harmonics (see the Wideband FFT graph in the *Typical Operating Characteristics*). The MAX9770 allows the switching frequency to be changed by +32% should the frequency of one or more harmonics fall in a sensitive band. This can be done during operation and does not affect audio reproduction.

## Spread-Spectrum Modulation (SSM) Mode

The MAX9770 features a unique, patented spread-spectrum mode that flattens the wideband spectral components, improving EMI emissions radiated by the speaker and cables by 5dB. Proprietary techniques

ensure that the cycle-to-cycle variation of the switching period does not degrade audio reproduction or efficiency (see the *Typical Operating Characteristics*). Select SSM mode by setting  $SYNC = V_{DD}$ . In SSM mode, the switching frequency varies randomly by  $\pm 120\text{kHz}$  around the center frequency (1.22MHz). The modulation scheme remains the same, but the period of the sawtooth waveform changes from cycle-to-cycle (Figure 2). Instead of a large amount of spectral energy present at multiples of the switching frequency, the energy is now spread over a bandwidth that increases with frequency. Above a few MHz, the wideband spectrum looks like white noise for EMI purposes (Figure 3).

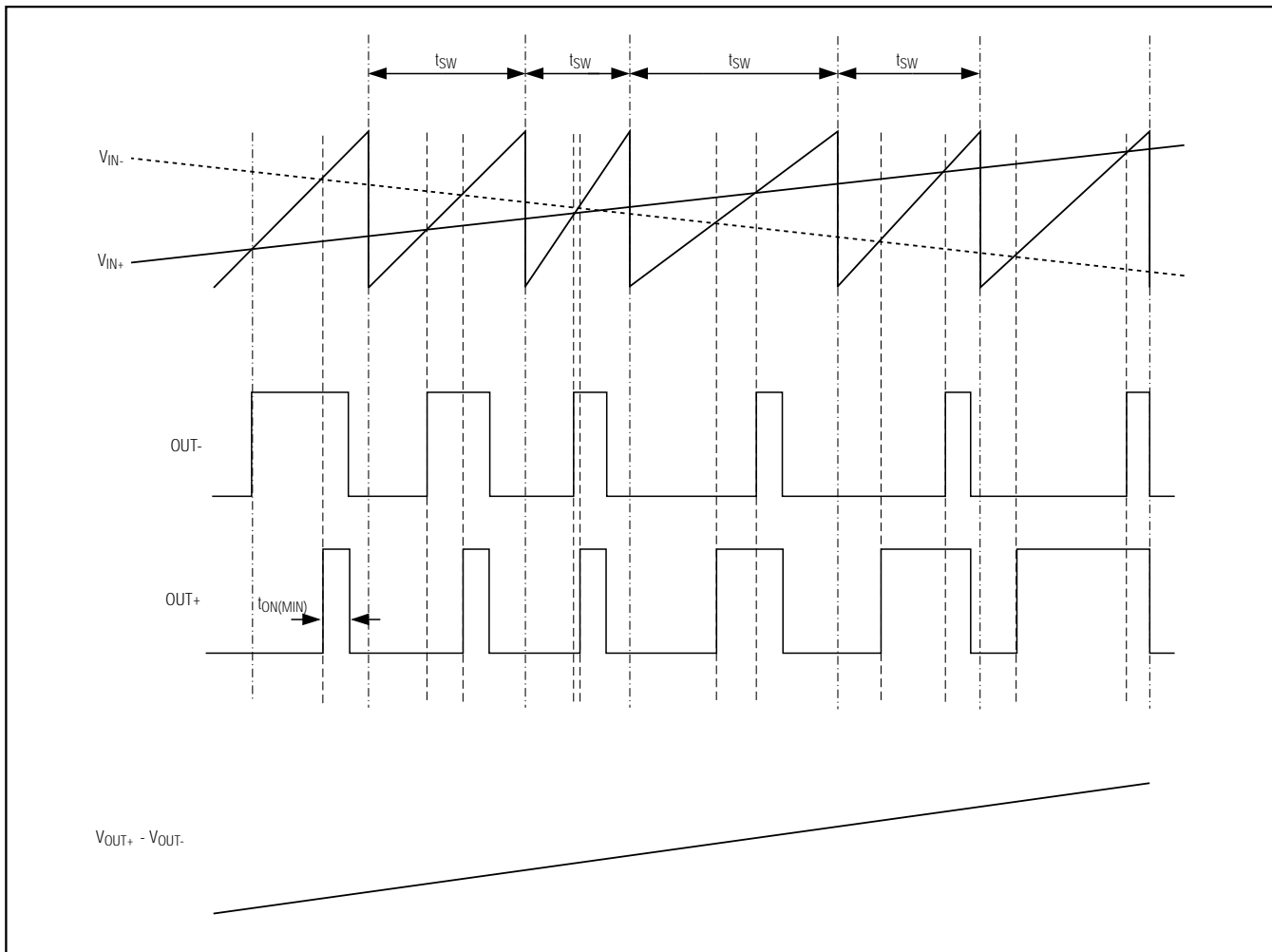

Figure 2. MAX9770 Output with an Input Signal Applied (SSM mode)

## 1.2W Low-EMI, Filterless, Mono Class D Amplifier with Stereo DirectDrive Headphone Amplifiers

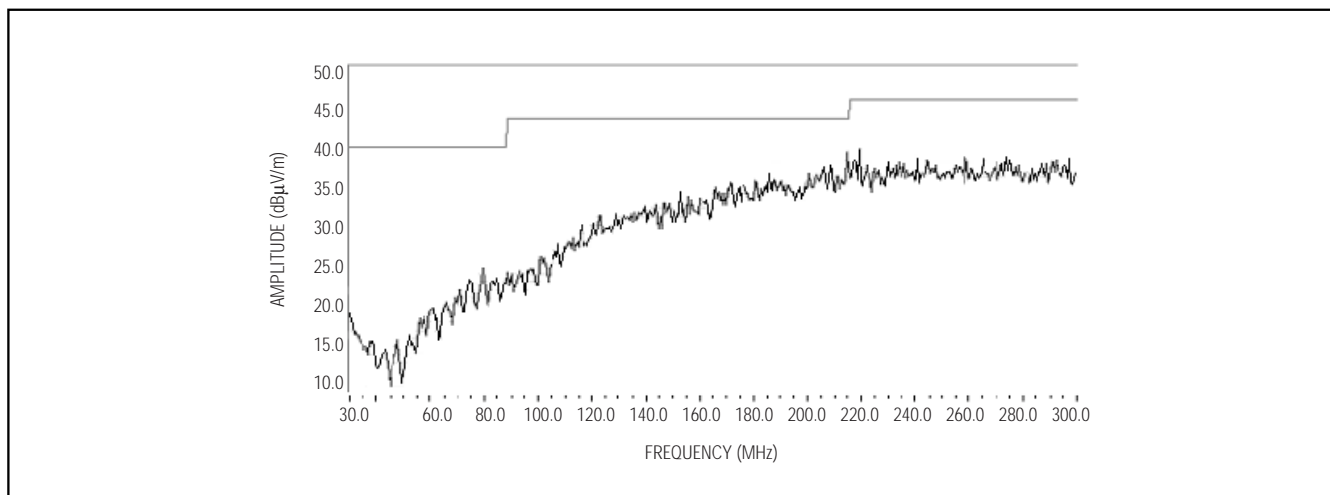

Figure 3. MAX9770 EMI with 75mm of Speaker Cable

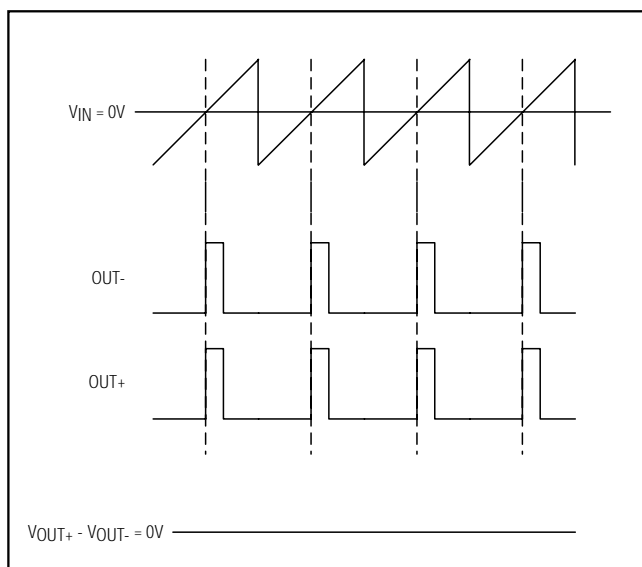

Figure 4. MAX9770 Output with No Signal Applied

### External Clock Mode

The SYNC input allows the MAX9770 to be synchronized to a system clock (allowing a fully synchronous system), or allocating the spectral components of the switching harmonics to insensitive frequency bands. Applying an external clock of 800kHz to 2MHz to SYNC

synchronizes the switching frequency of both the Class D and charge pump. The period of the SYNC clock can be randomized, enabling the MAX9770 to be synchronized to another spread-spectrum Class D amplifier operating in SSM mode.

### Filterless Modulation/Common-Mode Idle

The MAX9770 uses Maxim's unique, patented modulation scheme that eliminates the LC filter required by traditional Class D amplifiers, improving efficiency, reducing component count, conserving board space and system cost. Conventional Class D amplifiers output a 50% duty cycle square wave when no signal is present. With no filter, the square wave appears across the load as a DC voltage, resulting in finite load current, increasing power consumption. When no signal is present at the device input, the outputs switch as shown in Figure 4. Because the MAX9770 drives the speaker differentially, the two outputs cancel each other, resulting in no net idle mode voltage across the speaker, minimizing power consumption.

### Efficiency

Efficiency of a Class D amplifier is attributed to the region of operation of the output stage transistors. In a Class D amplifier, the output transistors act as current-steering switches and consume negligible additional power. Any power loss associated with the Class D output stage is mostly due to the  $I^2R$  loss of the MOSFET on-resistance, and quiescent current overhead.

# 1.2W Low-EMI, Filterless, Mono Class D Amplifier with Stereo DirectDrive Headphone Amplifiers

The theoretical best efficiency of a linear amplifier is 78%; however, that efficiency is only exhibited at peak output powers. Under normal operating levels (typical music reproduction levels), efficiency falls below 30%, whereas the MAX9770 still exhibits >80% efficiencies under the same conditions (Figure 5).

## DirectDrive

Traditional single-supply headphone drivers have their outputs biased about a nominal DC voltage (typically half the supply) for maximum dynamic range. Large coupling capacitors are needed to block this DC bias from the headphone. Without these capacitors, a significant amount of DC current flows to the headphone, resulting in unnecessary power dissipation and possible damage to both headphone and headphone driver.

Maxim's patented DirectDrive architecture uses a charge pump to create an internal negative supply voltage. This allows the headphone outputs of the MAX9770 to be biased about GND, almost doubling dynamic range while operating from a single supply. With no DC component, there is no need for the large DC-blocking capacitors. Instead of two large (220 $\mu$ F, typ) tantalum capacitors, the MAX9770 charge pump requires two small ceramic capacitors, conserving board space, reducing cost, and improving the frequency response of the headphone driver. See the Output Power vs. Charge-Pump Capacitance and Load Resistance graph in the *Typical Operating Characteristics* for details of the possible capacitor sizes. There is a low DC voltage on the driver outputs due to amplifier offset. However, the offset of the MAX9770 is typically 5mV, which, when combined with a 32 $\Omega$  load, results in less than 160 $\mu$ A of DC current flow to the headphones.

In addition to the cost and size disadvantages of the DC-blocking capacitors required by conventional headphone amplifiers, these capacitors limit the amplifier's low-frequency response and can distort the audio signal.

Previous attempts at eliminating the output-coupling capacitors involved biasing the headphone return (sleeve) to the DC bias voltage of the headphone amplifiers. This method raises some issues:

- 1) When combining a microphone and headphone on a single connector, the microphone bias scheme typically requires a 0V reference.
- 2) The sleeve is typically grounded to the chassis. Using the midrail biasing approach, the sleeve must be isolated from system ground, complicating product design.
- 3) During an ESD strike, the driver's ESD structures are the only path to system ground. Thus, the driver must be able to withstand the full ESD strike.

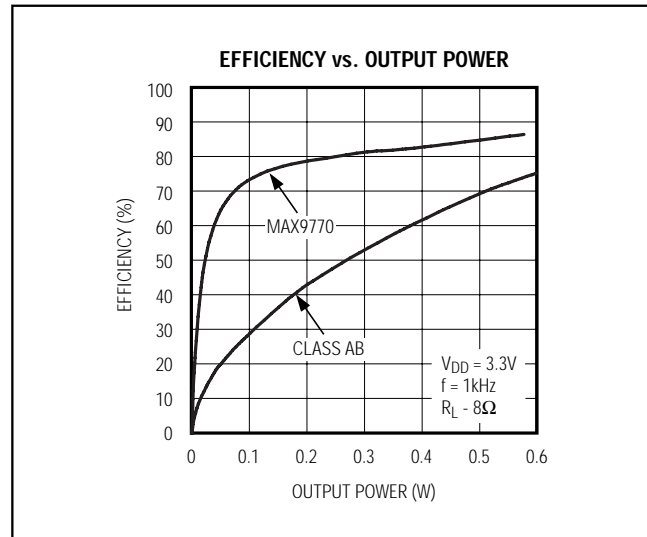

Figure 5. MAX9770 Efficiency vs. Class AB Efficiency

- 4) When using the headphone jack as a line out to other equipment, the bias voltage on the sleeve may conflict with the ground potential from other equipment, resulting in possible damage to the drivers.

## Charge Pump

The MAX9770 features a low-noise charge pump. The switching frequency of the charge pump is 1/2 the switching frequency of the Class D amplifier, regardless of the operating mode. When SYNC is driven externally, the charge pump switches at 1/2  $f_{SYNC}$ . When SYNC =  $V_{DD}$ , the charge pump switches with a spread-spectrum pattern. The nominal switching frequency is well beyond the audio range, and thus does not interfere with the audio signals, resulting in an SNR of 101dB. The switch drivers feature a controlled switching speed that minimizes noise generated by turn-on and turn-off transients. By limiting the switching speed of the charge pump, the di/dt noise caused by the parasitic bond wire and trace inductance is minimized. Although not typically required, additional high-frequency noise attenuation can be achieved by increasing the size of C2 (see *Typical Application Circuit*). The charge pump is active in both speaker and headphone modes.

## Input Multiplexer/Mixer

The MAX9770 features an input multiplexer/mixer that allows three different audio sources to be selected/mixed. Driving a SEL\_ input high selects the input channel (see Table 2), and the audio signal is output to the active amplifier. When a stereo path is selected in speaker mode (SEL1 or SEL2 = 1), the left and right

# 1.2W Low-EMI, Filterless, Mono Class D Amplifier with Stereo DirectDrive Headphone Amplifiers

**Table 2. Multiplexer/Mixer Settings**

SEL1	SEL2	SELM	HEADPHONE MODE		SPEAKER MODE
			HPOUTL	HPOUTR	
0	0	0	MUTE	MUTE	MUTE
1	0	0	IN1_L	IN1_R	(IN1_L + IN1_R) / 2
0	1	0	IN2_L	IN2_R	(IN2_L + IN2_R) / 2
0	0	1	MONO	MONO	MONO
1	1	0	(IN1_L + IN2_L) / 2	(IN1_R + IN2_R) / 2	(IN1_L + IN1_R + IN2_L + IN2_R) / 4
1	0	1	(IN1_L + MONO) / 2	(IN1_R + MONO) / 2	(IN1_L + IN1_R + MONO x 2) / 4
0	1	1	(IN2_L + MONO) / 2	(IN2_R + MONO) / 2	(IN2_L + IN2_R + MONO x 2) / 4
1	1	1	(IN1_L + IN2_L + MONO) / 3	(IN1_R + IN2_R + MONO) / 3	(IN1_L + IN1_R + IN2_L + IN2_R + MONO x 2) / 6

inputs are attenuated by 6dB and mixed together, resulting in a true mono reproduction of a stereo signal. When more than one signal path is selected, the sources are attenuated before mixing to preserve overall amplitude. Selecting two sources results in 6dB attenuation, selecting three sources results in 9.5dB attenuation.

### Headphone Sense Input (HPS)

The headphone sense input (HPS) monitors the headphone jack, and automatically configures the device based upon the voltage applied at HPS. A voltage of less than 0.8V sets the device to speaker mode. A voltage of greater than 2V disables the bridge amplifiers and enables the headphone amplifiers.

For automatic headphone detection, connect HPS to the control pin of a 3-wire headphone jack as shown in Figure 6. With no headphone present, the output impedance of the headphone amplifier pulls HPS to less than 0.8V. When a headphone plug is inserted into the jack, the control pin is disconnected from the tip contact and HPS is pulled to V<sub>DD</sub> through the internal 800kΩ pullup. When driving HPS from an external logic source, ground HPS when the MAX9770 is shut down. Place a 10kΩ resistor in series with HPS and the headphone jack to ensure ±8kV ESD protection.

Table 2 shows the output amplitude of the selected channels multiplied by the gain.

### BIAS

The MAX9770 features an internally generated, power-supply independent, common-mode bias voltage referenced to GND. BIAS provides both click-and-pop suppression and sets the DC bias level for the amplifiers. Choose the value of the bypass capacitor as described in the *BIAS Capacitor* section. No external load should be applied to BIAS. Any load lowers the BIAS voltage, affecting the overall performance of the device.

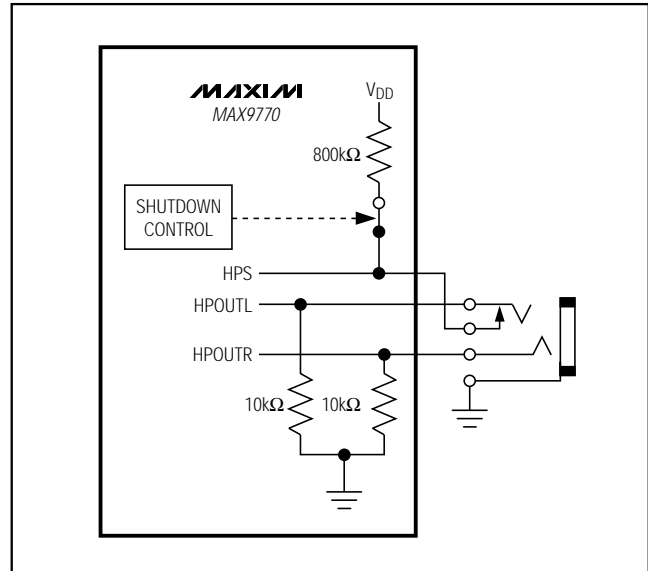

Figure 6. HPS Configuration

### Gain Selection

The MAX9770 features a logic-selectable, internally set gain. GAIN1 and GAIN2 set the gain of the MAX9770 speaker and headphone amplifiers as shown in Table 3.

The MAX9770 can be configured to automatically switch between two gain settings depending on whether the device is in speaker or headphone mode. By driving one or both gain inputs with HPS, the gain of the device changes when a headphone is inserted or removed. For example, the block diagram shows HPS connected to GAIN2, while GAIN1 is connected to V<sub>DD</sub>. In this configuration, the gain in speaker mode is 9dB, while the gain in headphone mode is 1dB. The gain settings with the HPS connection are shown in Table 4.

# 1.2W Low-EMI, Filterless, Mono Class D Amplifier with Stereo DirectDrive Headphone Amplifiers

**Table 3. Gain Selection**

GAIN1	GAIN2	SPEAKER GAIN (dB)	HEADPHONE GAIN (dB)	SPEAKER OUTPUT POWER ( $V_{IN} = 0.707V_{RMS}$ ) (mW)	SPEAKER OUTPUT POWER ( $V_{IN} = 1V_{RMS}$ ) (mW)	HEADPHONE OUTPUT POWER ( $V_{IN} = 0.707V_{RMS}$ ) (mW)	HEADPHONE OUTPUT POWER ( $V_{IN} = 1V_{RMS}$ ) (mW)
0	0	6	7	500 / 4Ω	500 / 8Ω	60* / 32Ω	60* / 32Ω
0	1	3	4	250 / 4Ω	500 / 4Ω	78 / 16Ω	60* / 32Ω
1	0	9	-2	500 / 8Ω	1000 / 8Ω	19 / 16Ω	39 / 16Ω
1	1	0	1	124 / 4Ω	250 / 4Ω	39 / 16Ω	78 / 16Ω

\*Output power limited to 60mW due to output voltage swing.

**Table 4. Gain Settings with HPS Connection**

GAIN1	GAIN2	SPEAKER MODE GAIN (HPS = 0)	HEADPHONE MODE GAIN (HPS = 1)
HPS	0	6	-2
HPS	1	3	1
0	HPS	6	4
1	HPS	9	1
HPS	HPS	6	1
0	0	6	7
0	1	3	4
1	0	9	-2
1	1	0	1

### Shutdown

The MAX9770 features a 0.1μA, low-power shutdown mode that reduces quiescent current consumption and extends battery life. Drive  $\overline{SHDN}$  low to disable the drive amplifiers, bias circuitry, and charge pump. Bias is driven to GND and the headphone amplifier output impedance is 10kΩ in shutdown. Connect  $\overline{SHDN}$  to  $V_{DD}$  for normal operation.

### Click-and-Pop Suppression

#### Speaker Amplifier

The MAX9770 speaker amplifier features comprehensive click-and-pop suppression that eliminates audible transients on startup and shutdown. While in shutdown, the H-bridge is in a high-impedance state. During startup or power-up, the input amplifiers are muted and an internal loop sets the modulator bias voltages to the correct levels, preventing clicks and pops when the H-bridge is subsequently enabled. For 30ms following startup, a soft-start function gradually unmutes the input amplifiers.

#### Headphone Amplifier

In conventional single-supply headphone drivers, the output-coupling capacitor is a major contributor of audible clicks and pops. Upon startup, the driver charges the coupling capacitor to its bias voltage, typically half the supply. Likewise, during shutdown, the capacitor is discharged to GND. This results in a DC shift across the capacitor, which in turn, appears as an audible transient at the speaker. Since the MAX9770 headphone amplifier does not require output-coupling capacitors, this does not arise.

Additionally, the MAX9770 features extensive click-and-pop suppression that eliminates any audible transient sources internal to the device. The Power-Up/Power-Down Waveform in the *Typical Operating Characteristics* shows that there are minimal spectral components in the audible range at the output upon startup or shutdown.

In most applications, the output of the preamplifier driving the MAX9770 has a DC bias of typically half the supply. During startup, the input-coupling capacitor is charged to the preamplifier's DC bias voltage through the  $R_F$  of the MAX9770, resulting in a DC shift across the capacitor and an audible click/pop. An internal delay of 50ms eliminates the click/pop caused by the input filter.

### Applications Information

#### Filterless Operation

Traditional Class D amplifiers require an output filter to recover the audio signal from the amplifier's output. The filters add cost, increase the solution size of the amplifier, and can decrease efficiency. The traditional PWM scheme uses large differential output swings (2 x  $V_{DD}$  peak-to-peak) at idle and causes large ripple currents. Any parasitic resistance in the filter components results in a loss of power, lowering efficiency.



## 1.2W Low-EMI, Filterless, Mono Class D Amplifier with Stereo DirectDrive Headphone Amplifiers

The MAX9770 does not require an output filter. The device relies on the inherent inductance of the speaker coil and the natural filtering of both the speaker and the human ear to recover the audio component of the square-wave output. Eliminating the output filter results in a smaller, less costly, and more efficient solution.

Because the frequency of the MAX9770 output is well beyond the bandwidth of most speakers, voice coil movement due to the square-wave frequency is minimal. Although this movement is small, a speaker not designed to handle the additional power may be damaged. For optimum results, use a speaker with a series inductance  $>10\mu\text{H}$ . Typical small  $8\Omega$  speakers exhibit series inductances in the range of  $20\mu\text{H}$  to  $100\mu\text{H}$ .

### Output Offset

Unlike Class AB amplifiers, the output offset voltage of a Class D amplifier does not noticeably increase quiescent current draw when a load is applied. This is due to the power conversion of the Class D amplifier. For example, a  $15\text{mV}$  DC offset across an  $8\Omega$  load results in  $1.9\text{mA}$  extra current consumption in a Class AB device. In the Class D case, a  $15\text{mV}$  offset into  $8\Omega$  equates to an additional power drain of  $28\mu\text{W}$ . Due to the high efficiency of the Class D amplifier, this represents an additional quiescent current draw of  $28\mu\text{W}/(V_{\text{DD}} / 100 \times \eta)$ , which is on the order of a few microamps.

### Power Supplies

The MAX9770 has different supplies for each portion of the device, allowing for the optimum combination of headroom and power dissipation and noise immunity. The speaker amplifiers are powered from  $PV_{\text{DD}}$ .  $PV_{\text{DD}}$  ranges from  $2.5\text{V}$  to  $5.5\text{V}$ . The headphone amplifiers are powered from  $V_{\text{DD}}$  and  $SV_{\text{SS}}$ .  $V_{\text{DD}}$  is the positive supply of the headphone amplifiers and ranges from  $2.5\text{V}$  to  $5.5\text{V}$ .  $SV_{\text{SS}}$  is the negative supply of the headphone amplifiers. Connect  $SV_{\text{SS}}$  to  $CPV_{\text{SS}}$ . The charge pump is powered by  $CPV_{\text{DD}}$ .  $CPV_{\text{DD}}$  ranges from  $2.5\text{V}$  to  $5.5\text{V}$  and should be the same potential as  $V_{\text{DD}}$ . The charge pump inverts the voltage at  $CPV_{\text{DD}}$ , and the resulting voltage appears at  $CPV_{\text{SS}}$ . The remainder of the device is powered by  $V_{\text{DD}}$ .

### Component Selection

#### Input Filter

The input capacitor ( $C_{\text{IN}}$ ), in conjunction with the amplifier input resistance ( $R_{\text{IN}}$ ), forms a highpass filter that

removes the DC bias from an incoming signal (see the *Typical Application Circuit*). The AC-coupling capacitor allows the amplifier to bias the signal to an optimum DC level. Assuming zero-source impedance, the  $-3\text{dB}$  point of the highpass filter is given by:

$$f_{-3\text{dB}} = \frac{1}{2\pi R_{\text{IN}} C_{\text{IN}}}$$

$R_{\text{IN}}$  is the amplifier's internal input resistance value given in the *Electrical Characteristics*. Be aware that the MONO input has a higher input impedance than the other inputs. Choose  $C_{\text{IN}}$  such that  $f_{-3\text{dB}}$  is below the lowest frequency of interest. Setting  $f_{-3\text{dB}}$  too high affects the amplifier's low-frequency response. Setting  $f_{-3\text{dB}}$  too low can affect the click-and-pop performance. Use capacitors with low-voltage coefficient dielectrics, such as tantalum or aluminum electrolytic. Capacitors with high-voltage coefficients, such as ceramics, may result in increased distortion at low frequencies.

#### Output Filter

The MAX9770 speaker amplifier does not require an output filter for normal operation and audio reproduction. The device passes FCC Class B radiated emissions standards with  $100\text{mm}$  of unshielded speaker cables. However, output filtering can be used if a design is failing radiated emissions due to board layout or cable length, or if the circuit is near EMI-sensitive devices. Use a common-mode choke connected in series with the speaker outputs if board space is limited and emissions are a concern. Use of an LC filter is necessary if excessive speaker cable is used.

#### BIAS Capacitor

BIAS is the output of the internally generated DC bias voltage. The BIAS bypass capacitor,  $C_{\text{BIAS}}$  improves PSRR and THD+N by reducing power supply and other noise sources at the common-mode bias node, and also generates the clickless/popless, startup/shutdown DC bias waveforms for the speaker amplifiers. Bypass BIAS with a  $0.047\mu\text{F}$  capacitor to GND. Large values of  $C_{\text{BIAS}}$  result in poor click/pop performance, and smaller values of  $C_{\text{BIAS}}$  result in degradation of PSRR and increased output noise.

# 1.2W Low-EMI, Filterless, Mono Class D Amplifier with Stereo DirectDrive Headphone Amplifiers

**Table 5. Suggested Capacitor Manufacturers**

SUPPLIER	PHONE	FAX	WEBSITE
Taiyo Yuden	800-348-2496	847-925-0899	www.t-yuden.com
TDK	807-803-6100	847-390-4405	www.component.tdk.com

### Charge-Pump Capacitor Selection

Use capacitors with an ESR less than 100mΩ for optimum performance. Low-ESR ceramic capacitors minimize the output resistance of the charge pump. Most surface-mount ceramic capacitors satisfy the ESR requirement. For best performance over the extended temperature range, select capacitors with an X7R dielectric. Table 5 lists suggested manufacturers.

### Flying Capacitor (C1)

The value of the flying capacitor (C1) affects the load regulation and output resistance of the charge pump. A C1 value that is too small degrades the device's ability to provide sufficient current drive, which leads to a loss of output voltage. Increasing the value of C1 may improve load regulation and reduces the charge-pump output resistance to an extent. Above 1μF, the on-resistance of the switches and the ESR of C1 and C2 dominate.

### Output Capacitor (C2)

The output capacitor value and ESR directly affect the ripple at CPV<sub>SS</sub>. Increasing the value of C2 reduces output ripple. Likewise, decreasing the ESR of C2 reduces both ripple and output resistance. Lower capacitance values can be used in systems with low maximum output power levels. See the Output Power vs. Charge Pump Capacitance and Load Resistance graph in the *Typical Operating Characteristics*.

### CPV<sub>DD</sub> Bypass Capacitor

The CPV<sub>DD</sub> bypass capacitor (C3) lowers the output impedance of the power supply and reduces the impact of the MAX9770's charge-pump switching transients. Bypass CPV<sub>DD</sub> with C3, the same value as C1, and place it physically close to the CPV<sub>DD</sub> and PGND (refer to the MAX9770 EV kit for a suggested layout).

### Layout and Grounding

Proper layout and grounding are essential for optimum performance. Use large traces for the power-supply inputs and amplifier outputs to minimize losses due to parasitic trace resistance, as well as route the head away from the device. Good grounding improves audio performance, minimizes crosstalk between channels, and prevents any switching noise from coupling into the audio signal. Connect CPGND, PGND, and GND together at a single point on the PC board. Route CPGND and all traces that carry switching transients away from GND, PGND, and the traces and components in the audio signal path.

Connect all components associated with the charge pump (C2 and C3) to the CPGND plane. Connect SV<sub>SS</sub> and CPV<sub>SS</sub> together at the device. Place the charge-pump capacitors (C1, C2, and C3) as close to the device as possible. Bypass V<sub>DD</sub> and PV<sub>DD</sub> with a 1μF capacitor to GND. Place the bypass capacitors as close to the device as possible.

Use large, low-resistance output traces. As load impedance decreases, the current drawn from the device outputs increase. At higher current, the resistance of the output traces decrease the power delivered to the load. Large output, supply, and GND traces also improve the power dissipation of the device.

The MAX9770 thin QFN package features an exposed thermal pad on its underside. This pad lowers the package's thermal resistance by providing a direct heat conduction path. Due to the high efficiency of the MAX9770's Class D amplifier, additional heatsinking is not required. If additional heatsinking is required, connect the exposed paddle to GND. See the MAX9770 EV kit data sheet for suggested component values and layout guidelines.

# 1.2W Low-EMI, Filterless, Mono Class D Amplifier with Stereo DirectDrive Headphone Amplifiers

Block Diagram

MAX9770

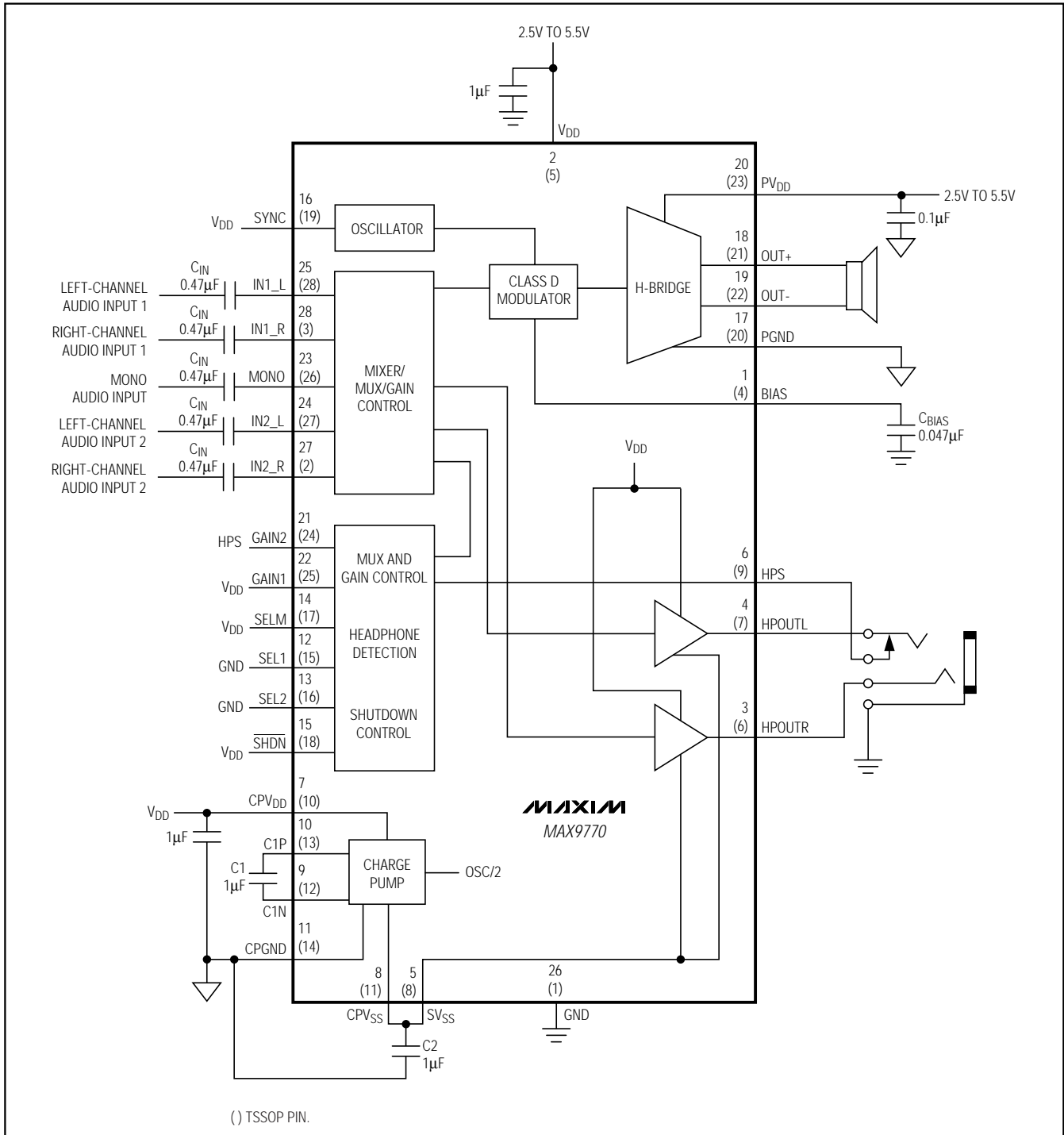

# 1.2W Low-EMI, Filterless, Mono Class D Amplifier with Stereo DirectDrive Headphone Amplifiers

System Diagram

MAX9770

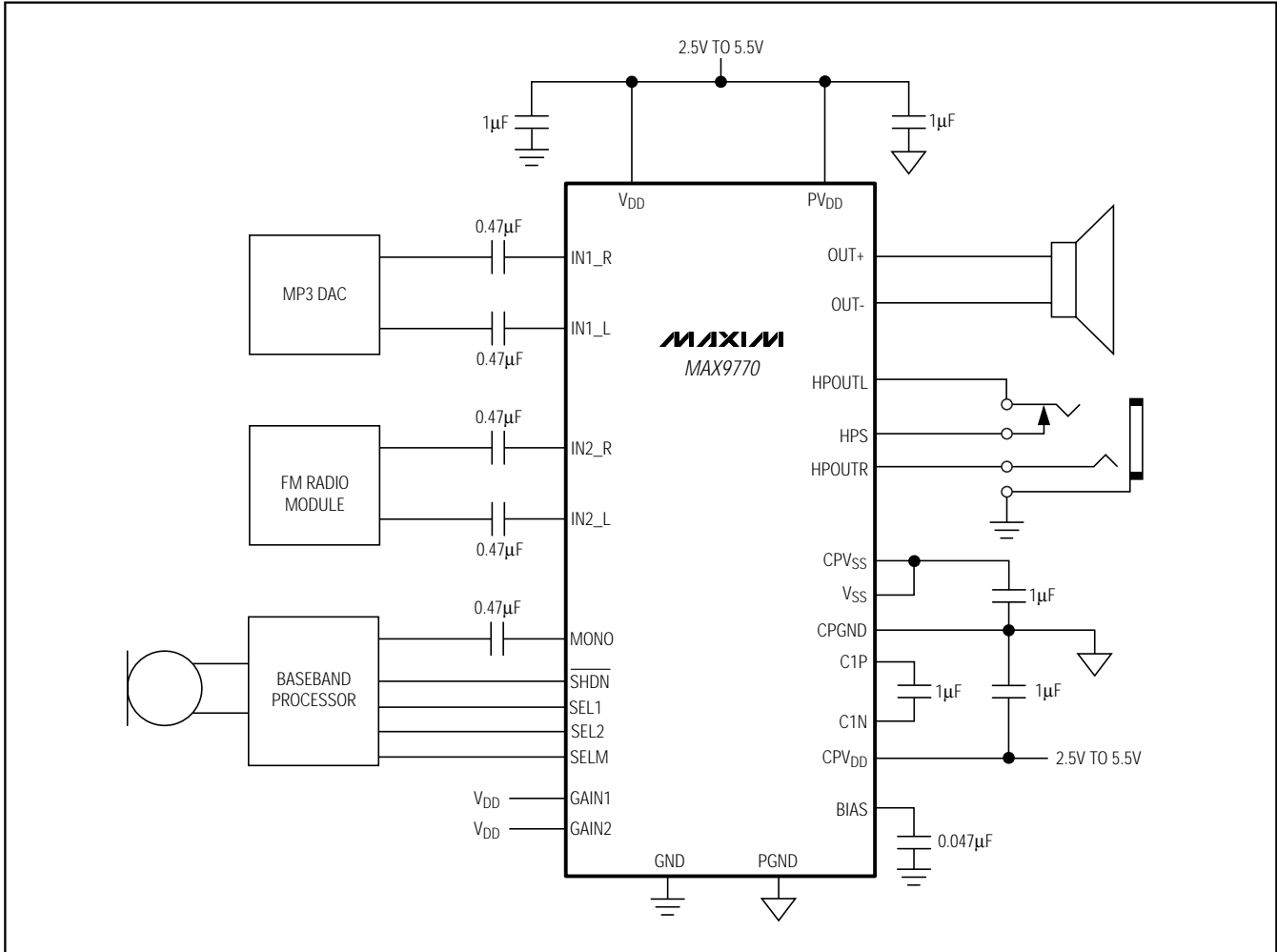

# 1.2W Low-EMI, Filterless, Mono Class D Amplifier with Stereo DirectDrive Headphone Amplifiers

## Pin Configurations

MAX9770

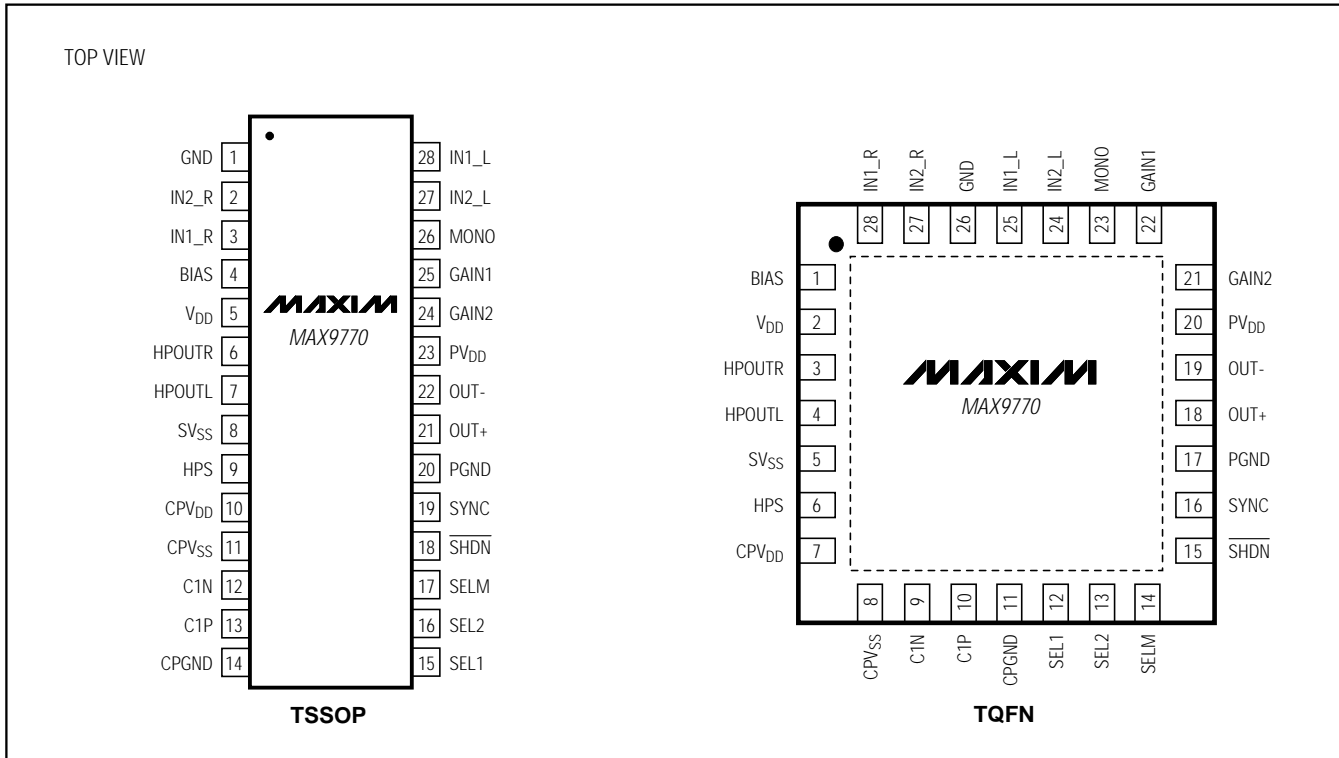

## Chip Information

TRANSISTOR COUNT: 7020

PROCESS: BICMOS

# 1.2W Low-EMI, Filterless, Mono Class D Amplifier with Stereo DirectDrive Headphone Amplifiers

## Package Information

(The package drawing(s) in this data sheet may not reflect the most current specifications. For the latest package outline information go to [www.maxim-ic.com/packages](http://www.maxim-ic.com/packages).)

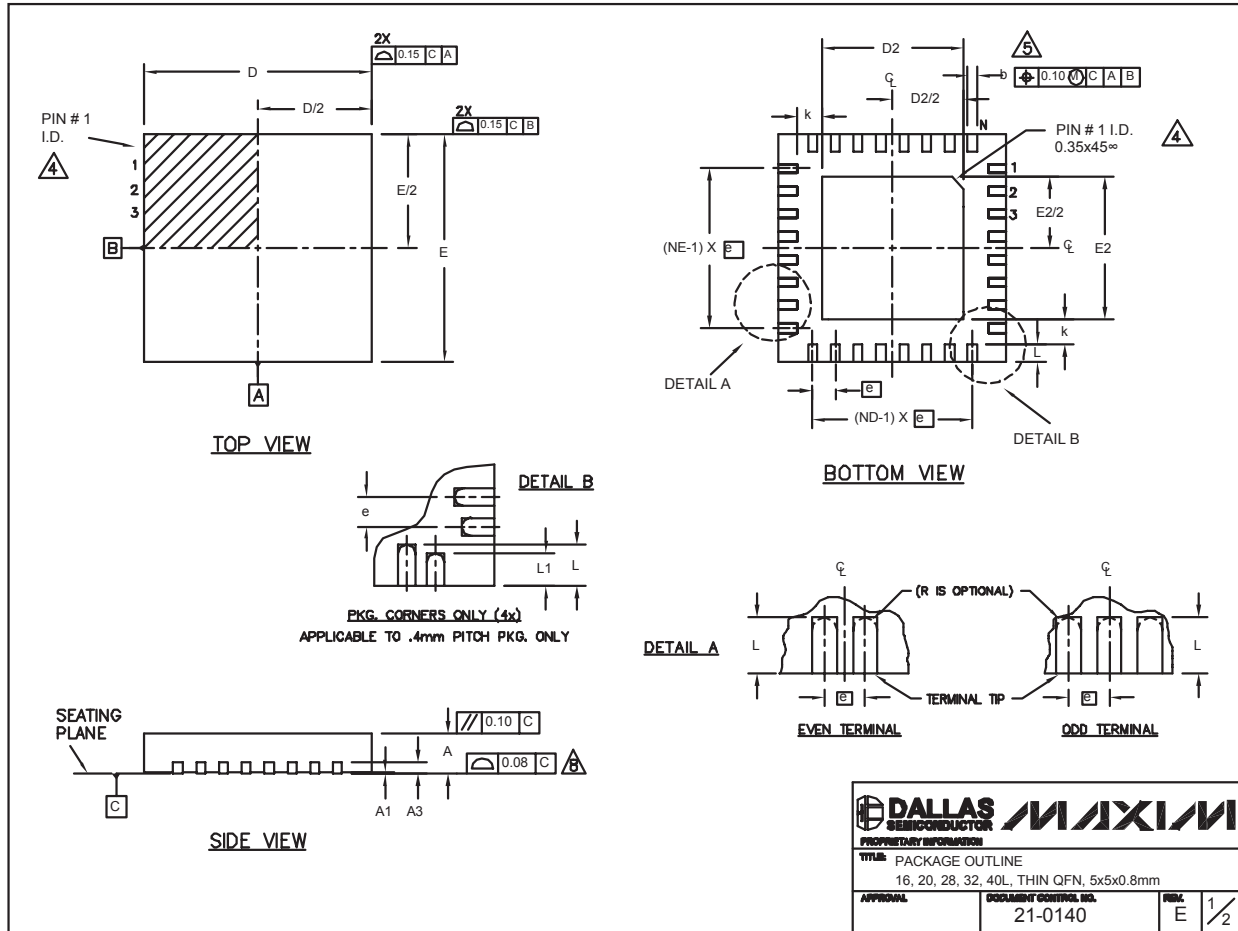

QFN THINLEPS

**Note:** The MAX9770 thin QFN package features an exposed thermal pad on its underside. This pad lowers the package's thermal resistance by providing a direct heat conduction path. Due to the high efficiency of the MAX9770's Class D amplifier, additional heatsinking is not required. The voltage of the exposed paddle is  $-V_{DD}$  and it is important that the exposed paddle is NOT connected to the ground plane. It should be either left floating or can be tied to the CPV<sub>SS</sub> pin. See the MAX9770 EV kit data sheet for suggested component values and layout guidelines.

# 1.2W Low-EMI, Filterless, Mono Class D Amplifier with Stereo DirectDrive Headphone Amplifiers

## Package Information (continued)

(The package drawing(s) in this data sheet may not reflect the most current specifications. For the latest package outline information go to [www.maxim-ic.com/packages](http://www.maxim-ic.com/packages).)

MAX9770

COMMON DIMENSIONS															EXPOSED PAD VARIATIONS								
PKG.	16L 5x5			20L 5x5			28L 5x5			32L 5x5			40L 5x5			PKG. CODES	D2			E2			DOWN BONDS ALLOWED
SYMBOL	MIN.	NOM.	MAX.	MIN.	NOM.	MAX.	MIN.	NOM.	MAX.	MIN.	NOM.	MAX.	MIN.	NOM.	MAX.		MIN.	NOM.	MAX.	MIN.	NOM.	MAX.	
A	0.70	0.75	0.80	0.70	0.75	0.80	0.70	0.75	0.80	0.70	0.75	0.80	0.70	0.75	0.80	T1655-1	3.00	3.10	3.20	3.00	3.10	3.20	NO
A1	0	0.02	0.05	0	0.02	0.05	0	0.02	0.05	0	0.02	0.05	0	-	0.05	T1655-2	3.00	3.10	3.20	3.00	3.10	3.20	YES
A3	0.20 REF.			0.20 REF.			0.20 REF.			0.20 REF.			0.20 REF.			T2055-2	3.00	3.10	3.20	3.00	3.10	3.20	NO
b	0.25	0.30	0.35	0.25	0.30	0.35	0.20	0.25	0.30	0.20	0.25	0.30	0.15	0.20	0.25	T2055-3	3.00	3.10	3.20	3.00	3.10	3.20	YES
D	4.90	5.00	5.10	4.90	5.00	5.10	4.90	5.00	5.10	4.90	5.00	5.10	4.90	5.00	5.10	T2055-4	3.00	3.10	3.20	3.00	3.10	3.20	NO
E	4.90	5.00	5.10	4.90	5.00	5.10	4.90	5.00	5.10	4.90	5.00	5.10	4.90	5.00	5.10	T2855-1	3.15	3.25	3.35	3.15	3.25	3.35	NO
e	0.80 BSC.			0.65 BSC.			0.50 BSC.			0.50 BSC.			0.40 BSC.			T2855-2	2.60	2.70	2.80	2.60	2.70	2.80	NO
k	0.25	-	-	0.25	-	-	0.25	-	-	0.25	-	-	0.25	0.35	0.45	T2855-3	3.15	3.25	3.35	3.15	3.25	3.35	YES
L	0.30	0.40	0.50	0.45	0.55	0.65	0.45	0.55	0.65	0.30	0.40	0.50	0.40	0.50	0.60	T2855-4	2.60	2.70	2.80	2.60	2.70	2.80	YES
L1	-	-	-	-	-	-	-	-	-	-	-	-	0.30	0.40	0.50	T2855-5	2.60	2.70	2.80	2.60	2.70	2.80	NO
N	16			20			28			32			40			T2855-6	3.15	3.25	3.35	3.15	3.25	3.35	NO
ND	4			5			7			8			10			T2855-7	2.60	2.70	2.80	2.60	2.70	2.80	YES
NE	4			5			7			8			10			T3255-2	3.00	3.10	3.20	3.00	3.10	3.20	NO
JEDEC	WHHB			WHHC			WHHD-1			WHHD-2			-			T3255-3	3.00	3.10	3.20	3.00	3.10	3.20	YES
																T3255-4	3.00	3.10	3.20	3.00	3.10	3.20	NO
																T4055-1	3.20	3.30	3.40	3.20	3.30	3.40	YES

NOTES:

- DIMENSIONING & TOLERANCING CONFORM TO ASME Y14.5M-1994.
- ALL DIMENSIONS ARE IN MILLIMETERS. ANGLES ARE IN DEGREES.
- N IS THE TOTAL NUMBER OF TERMINALS.
- THE TERMINAL #1 IDENTIFIER AND TERMINAL NUMBERING CONVENTION SHALL CONFORM TO JESD 95-1 SPP-012. DETAILS OF TERMINAL #1 IDENTIFIER ARE OPTIONAL, BUT MUST BE LOCATED WITHIN THE ZONE INDICATED. THE TERMINAL #1 IDENTIFIER MAY BE EITHER A MOLD OR MARKED FEATURE.
- DIMENSION b APPLIES TO METALLIZED TERMINAL AND IS MEASURED BETWEEN 0.25 mm AND 0.30 mm FROM TERMINAL TIP.
- ND AND NE REFER TO THE NUMBER OF TERMINALS ON EACH D AND E SIDE RESPECTIVELY.
- DEPOPULATION IS POSSIBLE IN A SYMMETRICAL FASHION.
- COPLANARITY APPLIES TO THE EXPOSED HEAT SINK SLUG AS WELL AS THE TERMINALS.
- DRAWING CONFORMS TO JEDEC MO220, EXCEPT EXPOSED PAD DIMENSION FOR T2855-1, T2855-3 AND T2855-6.
- WARPAGE SHALL NOT EXCEED 0.10 mm.

  

TITLE: PACKAGE OUTLINE 16, 20, 28, 32, 40L, THIN QFN, 5x5x0.8mm	
APPROVAL:	DOCUMENT CONTROL NO. 21-0140
REVISION: E	DATE: 2/2

# 1.2W Low-EMI, Filterless, Mono Class D Amplifier with Stereo DirectDrive Headphone Amplifiers

## Package Information (continued)

(The package drawing(s) in this data sheet may not reflect the most current specifications. For the latest package outline information go to [www.maxim-ic.com/packages](http://www.maxim-ic.com/packages).)

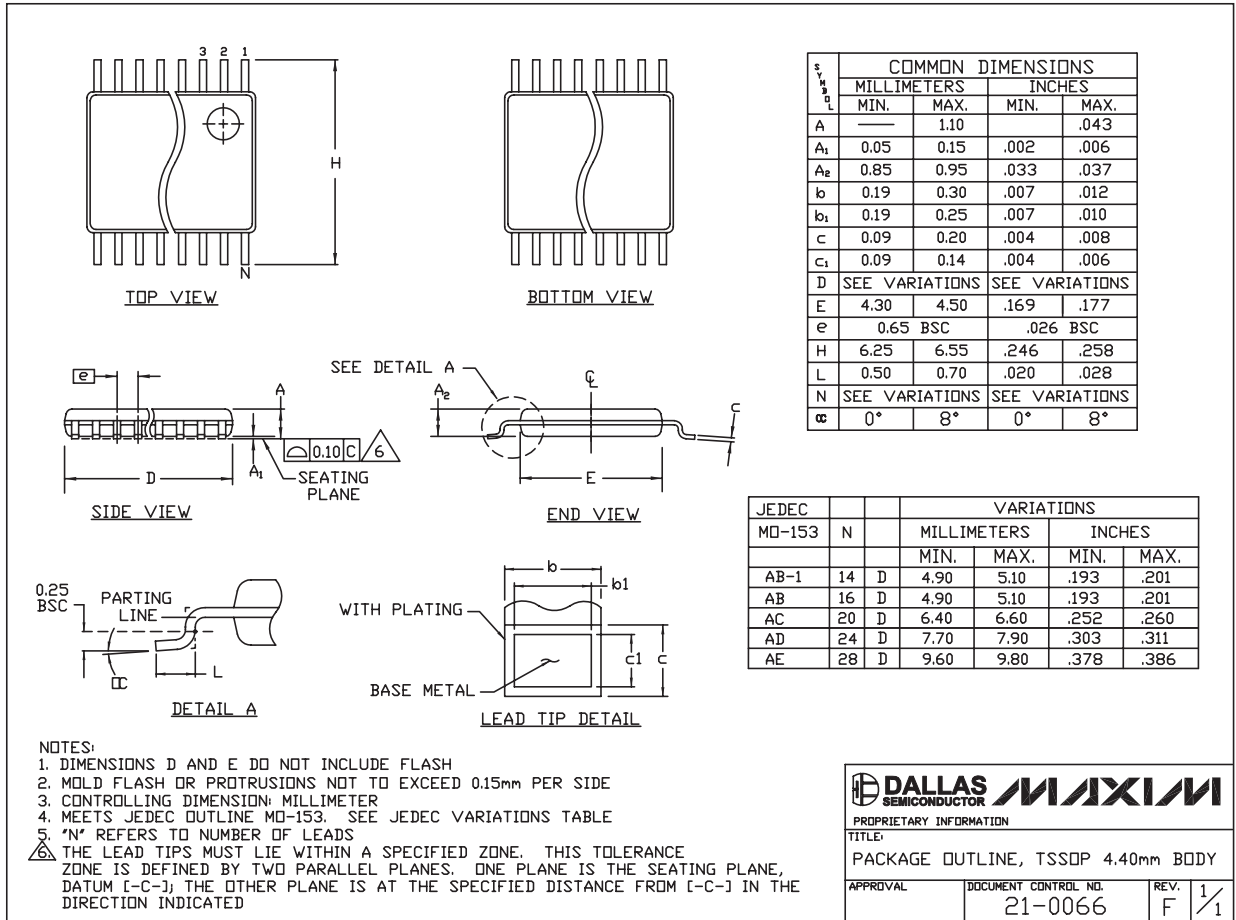

TSSOP4, 4.0mm, EPS

Maxim cannot assume responsibility for use of any circuitry other than circuitry entirely embodied in a Maxim product. No circuit patent licenses are implied. Maxim reserves the right to change the circuitry and specifications without notice at any time.

24 \_\_\_\_\_ Maxim Integrated Products, 120 San Gabriel Drive, Sunnyvale, CA 94086 408-737-7600